

# ESTOFADOS

20  
24



UPHOLSTERY  
TAPICERÍA





Conheça mais a indústria  
do Grupo Herval.

Find out more about the  
Herval Group industry.

Obtenga más información sobre  
la industria del Grupo Herval.



# TUDO DE MELHOR

PARA VOCÊ E PARA O MEIO AMBIENTE.  
ALL THE BEST FOR YOU AND THE ENVIRONMENT.  
TODO MEJOR PARA USTED Y PARA EL MEDIO AMBIENTE.

# CONFORTO

Comfort | Comodidad

Conforto também é estar em equilíbrio com o mundo em que vivemos. É por isso que estamos conectados ao meio ambiente, com iniciativas que geram impacto positivo.

Em 2019, conquistamos a certificação FSC, que reconhece o atendimento de toda a cadeia de custódia e fornecimento dentro do conceito de remanejamento florestal. As espumas de PU e os produtos Herval são certificados como ecologicamente corretos, pela utilização de sistemas que limitam a emissão dos gases que agredem a camada de ozônio. Adotamos práticas de responsabilidade social que atendem à grande gama de requisitos da norma AS 8000. Minimizamos a geração de resíduos e, ainda, conscientizamos colaboradores e comunidade para a destinação e processamento adequados de resíduos nos âmbitos fabril e familiar.

*Comfort is also about being in balance with the world we live in. That is why we are connected to the environment, with initiatives that generate a positive impact. In 2019, we achieved FSC certification, which recognizes the service of the entire chain of custody and supply within the concept of forest management. PU Foams and Herval products are certified as ecologically correct, due to the use of systems that limit the emission of gases that harm the ozone layer. We adopt social responsibility practices that meet the wide range of requirements of the AS 8000 standard. We minimize the generation of waste, and also raise the awareness of employees and the community about the proper destination and processing of waste at the industrial and family levels.*

*La comodidad también se trata de estar en equilibrio con el mundo en el que vivimos. Por eso estamos conectados con el medio ambiente, con iniciativas que generan un impacto positivo. En 2019 logramos la certificación FSC, que reconoce el servicio de toda la cadena de custodia y suministro dentro del concepto de manejo forestal. Las Espumas de PU y los productos Herval están certificados como ecológicamente correctos, debido al uso de sistemas que limitan la emisión de gases que dañan la capa de ozono. Adoptamos prácticas de responsabilidad social que cumplen con la amplia gama de requisitos de la norma AS 8000. Minimizamos la generación de residuos, y también sensibilizamos a los colaboradores y a la comunidad sobre el destino y tratamiento adecuado de los residuos a nivel industrial y familiar.*

# REQUINTE

Refinement | Refinamiento

- 1.** extremo grau de aperfeiçoamento, refinamento.
- 2.** compartilhar momentos inesquecíveis em um lugar inspirador.
- 3.** ler um livro ou relaxar em um espaço que é puro design e conforto.
- 4.** ter muitas possibilidades ao seu dispor, com uma linha de estofados que deixam cada ambiente repleto de vida e estilo.
- 5.** combinar a inovação e sustentabilidade que existe em cada produto com os mais de 60 anos de tradição de uma marca que entrega excelência da escolha da matéria-prima ao acabamento impecável.
- 6.** sentar, se jogar e curtir a vida em um estofado Herval.

- 1.** *extreme degree of enhancement, refinement.*
- 2.** *share unforgettable memories in an inspiring place.*
- 3.** *read a book or relax in a space that is pure design and comfort.*
- 4.** *have endless possibilities at your disposal, with a line of upholstered furniture that gives each environment life and style.*
- 5.** *combine the innovation and sustainability that exists in each product with the over 60 years of tradition of a brand that delivers excellence, from selecting the raw material to the impeccable finish.*
- 6.** *sit down, lay back and enjoy life in a piece of Herval upholstered furniture.*

- 1.** *grado extremo de perfeccionamiento, refinamiento.*
- 2.** *compartir momentos inolvidables en un lugar inspirador.*
- 3.** *leer un libro o relajarse en un espacio que es puro diseño y comodidad.*
- 4.** *tener muchas posibilidades a su disposición, con una línea de tapizados que hace que cada habitación esté llena de vida y estilo.*
- 5.** *combinar la innovación y la sostenibilidad que existe en cada producto con los más de 60 años de tradición de una marca que ofrece la excelencia desde la elección de la materia prima hasta el impecable acabado.*
- 6.** *sentarse, tirarse y disfrutar de la vida en un tapizado Herval.*

SUMÁRIO

SUMMARY

RESUMEN



**MH 1174** | 118  
**MH 1216** | 102  
**MH 1217** | 95  
**MH 1235** | 84  
**MH 1237** | 103  
**MH 1456** | 119  
**MH 1496** | 119  
**MH 1605** | 120  
**MH 1606** | 121  
**MH 1609** | 122  
**MH 1610** | 123  
**MH 2650** | 114  
**MH 2651** | 110  
**MH 2680** | 115  
**MH 2690** | 112  
**MH 2694** | 111  
**MH 2696** | 111  
**MH 3601** | 104  
**MH 3605** | 105  
**MH 3678** | 96,97  
**MH 3685** | 85  
**MH 3721** | 126  
**MH 3722** | 127  
**MH 3724** | 132  
**MH 3747** | 86  
**MH 3783** | 87  
**MH 3784** | 88  
**MH 3785** | 89  
**MH 3788** | 90  
**MH 3789** | 91  
**MH 3790** | 98  
**MH 3791** | 99  
**MH 3792** | 100  
**MH 3795** | 92  
**MH 3801** | 93  
**MH 3807** | 81  
**MH 3808** | 101  
**MH 3809** | 78  
**MH 3814** | 79  
**MH 3815** | 80  
**MH 3816** | 94  
**MH 3817** | 82,83  
**MH 4011** | 70,71  
**MH 4032** | 40,41,42,43  
**MH 4108** | 64  
**MH 4130** | 44,45,124,125  
**MH 4163** | 22,23,24,25  
**MH 4168** | 51  
**MH 4177** | 26,27  
**MH 4179** | 65  
**MH 4185** | 68  
**MH 4187** | 52  
**MH 4191** | 76,77  
**MH 4192** | 46,47  
**MH 4194** | 48  
**MH 4203** | 49  
**MH 4205** | 28,29  
**MH 4206** | 30,31  
**MH 4208** | 32,33  
**MH 4209** | 53  
**MH 4210** | 54  
**MH 4211** | 69  
**MH 4212** | 66,67  
**MH 4214** | 72  
**MH 4215** | 73  
**MH 4216** | 34,35  
**MH 4219** | 55  
**MH 4220** | 74  
**MH 4221** | 75  
**MH 4223** | 36,37  
**MH 4225** | 56  
**MH 4226** | 57  
**MH 4227** | 58,59  
**MH 4229** | 50  
**MH 4236** | 38  
**MH 4237** | 39  
**MH 4241** | 12,13  
**MH 4242** | 60,61  
**MH 4244** | 14,15  
**MH 4245** | 16,17  
**MH 4246** | 18,19  
**MH 4247** | 20,21  
**MH 4248** | 62,63  
**MH 6007** | 116  
**MH 6008** | 117  
**MH 6014** | 113  
**MH 6016** | 108  
**MH 6017** | 109  
**MH 6019** | 106  
**MH 6020** | 107  
**MH 7523** | 135  
**MH 7526** | 135  
**MH 7552** | 133  
**MH 7584** | 133  
**MH 7560** | 134  
**MH 7599** | 134  
**MH 7600** | 135  
**MH 7601** | 135  
**MH 9811** | 128  
**MH 9812** | 129  
**MH 9813** | 130  
**MH 9814** | 131

Descubra a linha de produtos que  
vai deixar o seu lar ainda mais  
funcional e cheio de estilo.

*Discover the line of products that  
will make your home even more  
functional and stylish.*

*Descubra la línea de productos  
que hará que su hogar sea aún  
más funcional y repleto de estilo.*



# ESTO FADOS

UPHOLSTERY | TAPICERÍA



MH 4241

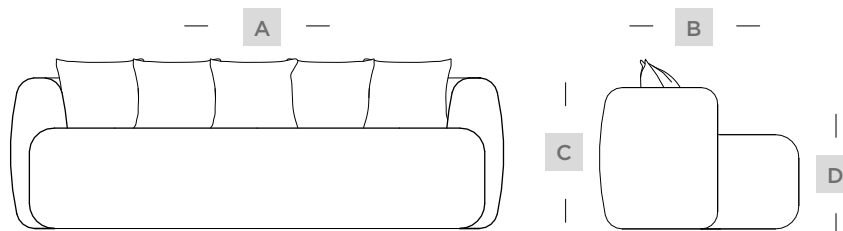

MH 4241									
LUGARES	BRAÇOS	A		B		C		D	
Nº	Nº	CM	POL.	CM	POL.	CM	POL.	CM	POL.
4	2	282	111"	100	39"	76	29"	42	16"
3,5		240	94"						
3		200	78"						
Banqueta		80	31"	95	37"				

A - largura | B - profundidade | C - altura | D - altura do assento



MH 4241



# TENDÈNCIA

TREND  
TENDENCIA



MH 4244





MH 4244

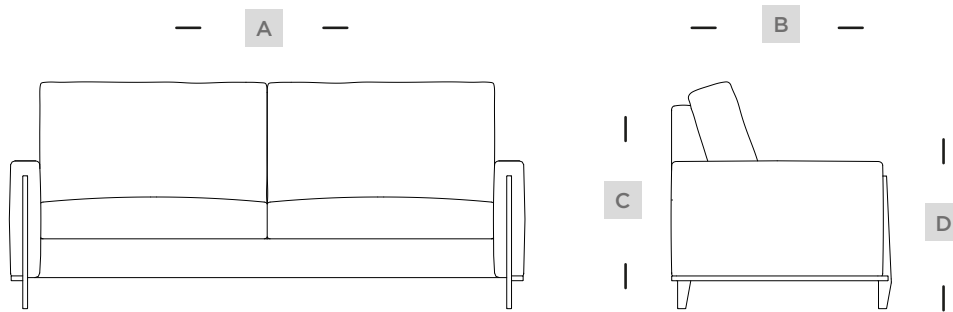

MH 4244									
LUGARES	BRAÇOS	A		B		C		D	
N°	N°	CM	POL.	CM	POL.	CM	POL.	CM	POL.
4	2	242	95"	88	34"	92	36"	47	18"
3		212	83"						
2		182	71"						
A - largura   B - profundidade   C - altura   D - altura do assento									



MH 4245

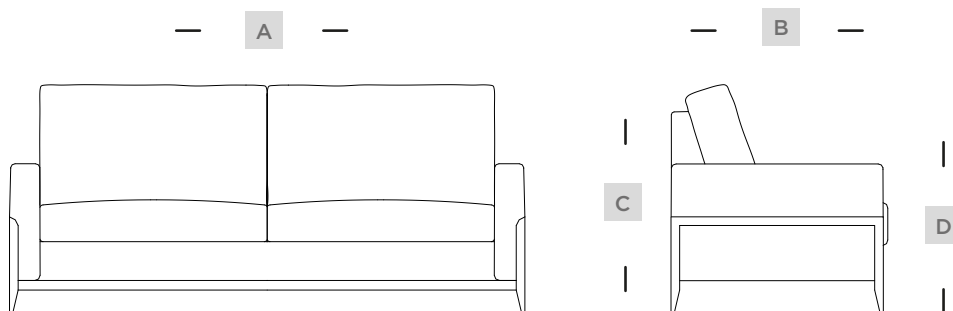

MH 4245									
LUGARES	BRAÇOS	A		B		C		D	
N°	N°	CM	POL.	CM	POL.	CM	POL.	CM	POL.
4	2	239	94"	88	34"	93	36"	47	18"
3		209	82"						
2		179	94"						

A - largura | B - profundidade | C - altura | D - altura do assento





MH 4245





MH 4246





MH 4246

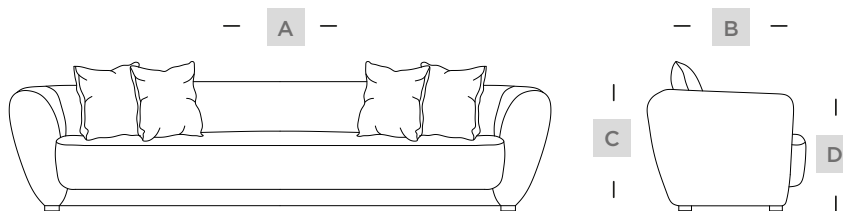

MH 4246									
LUGARES	BRAÇOS	A		B		C		D	
Nº	Nº	CM	POL.	CM	POL.	CM	POL.	CM	POL.
4	2	296	116"	92	36"	78	30"	45	17"
3		236	92"						
A - largura   B - profundidade   C - altura   D - altura do assento									



MH 4247

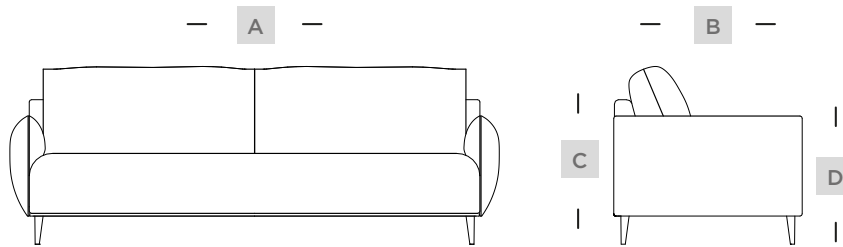

MH 4247									
LUGARES	BRAÇOS	A		B		C		D	
Nº	Nº	CM	POL.	CM	POL.	CM	POL.	CM	POL.
4	2	270	106"	87	34"	86	33"	45	17"
3		223	87"						
2		181	71"						
1		102	40"						

A - largura | B - profundidade | C - altura | D - altura do assento



MH 4247



DESIGN



MH 4163



# MODERNO

MODERN  
MODERNO



MH 4163





MH 4163







MH 4163

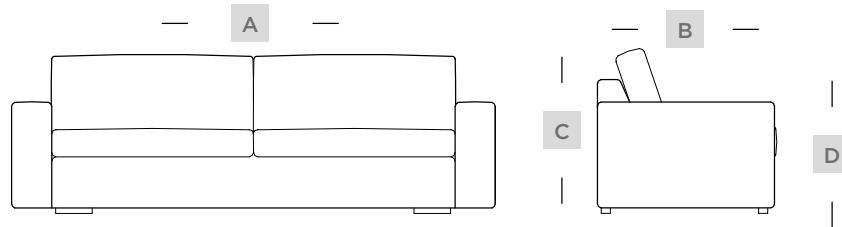

MH 4163											
LUGARES	BRAÇOS		ASSENTO	A		B		C		D	
Nº	Nº	LARGURA (CM)	CM	CM	POL.	CM	POL.	CM	POL.	CM	POL.
4	2	22	-	265	104"	99	38"	86	33"	46	18"
		14		249	98"						
	1	22		243	95"						
		14		235	92"						
3	2	22	-	225	88"	99	38"	86	33"	46	18"
		14		209	82"						
	1	22		203	79"						
		14		195	76"						
Módulo	2	22	110	154	52"	99	38"	86	33"	46	18"
		14		138	54"						
	1	22		132	51"						
		14		124	48"						
-	-	-	110	43"	-	-	-	-	-	-	
Módulo	2	22	90	134	52"	99	38"	86	33"	46	18"
		14		118	46"						
	1	22		112	44"						
		14		104	44"						
-	-	-	90	35"	-	-	-	-	-	-	
Chaise longue	1	22	110	134	52"	158	62"	86	33"	46	18"
14		126		49"							
Chaise longue	1	22	90	114	44"	158	62"	86	33"	46	18"
14		106		41"							
Canto 60°	-	-	-	201	78"	115	45"	86	33"	46	18"
Canto	-	-	-	180	70"	106	41"				
Canto chaise	1	22	-	208	81"	148	58"	-	-	-	-
14		200		78"	-			-	-	-	
Banqueta quadrada	-	-	-	100	39"	100	39"	46	18"	46	18"
Banqueta retangular	-	-	-	180	70"	100	39"	46	18"	46	18"
Encosto solto	-	-	-	80	31"	50	19"	46	18"	-	-

A - largura | B - profundidade | C - altura | D - altura do assento



MH 4177





MH 4177

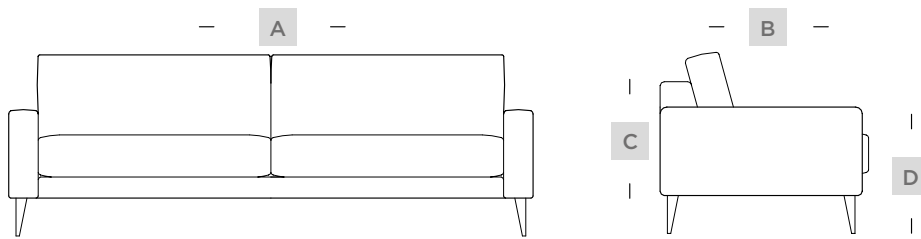

MH 4177										
LUGARES	BRAÇOS		A		B		C		D	
N°	N°	LARGURA (CM)	CM	POL.	CM	POL.	CM	POL.	CM	POL.
4	2	22	265	104"	99	38"	86	33"	50	18"
		14	249	98"						
3,5	2	22	245	96"						
		14	229	90"						
3	2	22	225	88"						
		14	209	82"						
2,5	2	22	205	80"						
		14	189	74"						

A - largura | B - profundidade | C - altura | D - altura do assento



MH 4205

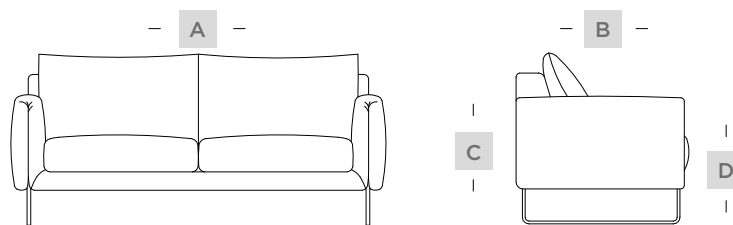

MH 4205									
LUGARES	BRAÇOS	A		B		C		D	
Nº	Nº	CM	POL.	CM	POL.	CM	POL.	CM	POL.
3	2	235	92"	94	37"	93	36"	49	19"
	1	220	88"						
2,5	2	203	77"						
	1	187	73"						
Poltrona	2	120	47"						
	1	102	40"						
	-	87	34"						

A - largura | B - profundidade | C - altura | D - altura do assento



MH 4205





MH 4206





MH 4206

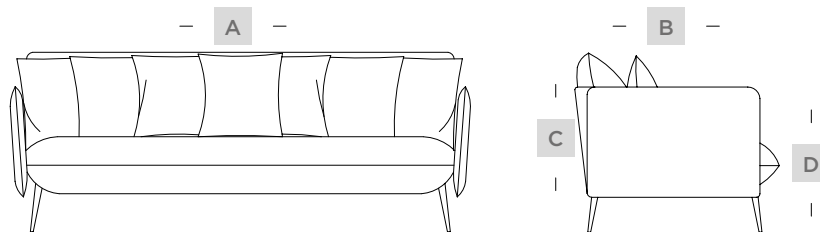

MH 4206									
LUGARES	BRAÇOS	A		B		C		D	
N°	N°	CM	POL.	CM	POL.	CM	POL.	CM	POL.
4	2	258	101"	97	38"	85	33"	45	17"
3		218	85"						
Poltrona		90	35"						

A - largura | B - profundidade | C - altura | D - altura do assento



MH 4208

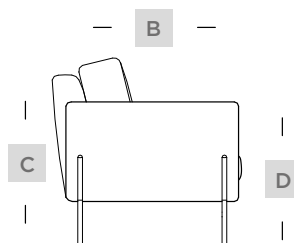
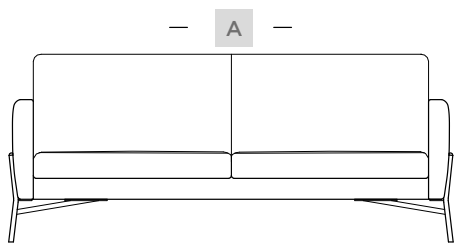

MH 4208										
LUGARES	BRAÇOS		A		B		C		D	
N°	N°	LARGURA (CM)	CM	POL.	CM	POL..	CM	POL.	CM	POL.
4	2	18	281	110"	93	36"	88	34"	48	18"
	1		261	102"						
	2	10	265	104"						
	1		253	99"						
3	2	18	241	94"	93	36"	88	34"	48	18"
	1		221	87"						
	2	10	225	88"						
	1		213	83"						
2,5	2	18	221	87"	93	36"	88	34"	48	18"
	1		201	79"						
	2	10	205	80"						
	1		193	75"						
Poltrona	2	-	94	37"	93	36"	88	34"	48	18"
Chaise longue	1	10	112	44"	148	58"	88	34"	48	18"
	1	18	120	47"						
	2	10	124	48"						
	2	18	140	55"						
Banqueta	-	-	110	43"	70	36"	49	34"	49	18"
	-	-	90	35"						

A - largura | B - profundidade | C - altura | D - altura do assento





MH 4208



REFINEMENT  
REFINAMIENTO

# RE QUIN TE



MH 4216

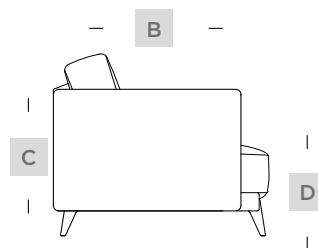
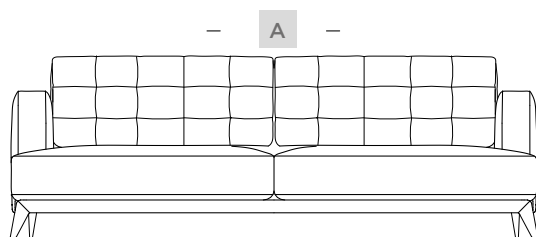

MH 4216										
LUGARES		BRAÇOS	A		B		C		D	
Nº	TIPO	Nº	CM	POL.	CM	POL.	CM	POL.	CM	POL.
4	Bipartido	2	280	110"	98	38"	82	32"	45	17"
3	-	2	242	95"						
3	Chaise	1	247	97"						
2	-	2	206	81"						
1	Poltrona	2	102	40"						

A - largura | B - profundidade | C - altura | D - altura do assento



MH 4216





MH 4223

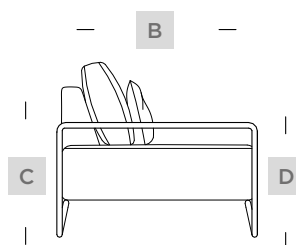
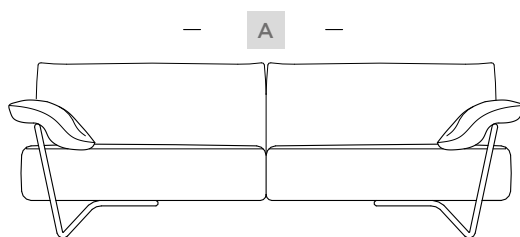

MH 4223									
LUGARES	BRAÇOS	A		B		C		D	
Nº	Nº	CM	POL.	CM	POL.	CM	POL.	CM	POL.
4	2	260	102"	102	40"	88	34"	44	17"
3		220	86"						
2		180	70"						

A - largura | B - profundidade | C - altura | D - altura do assento



MH 4223





MH 4236



— A —

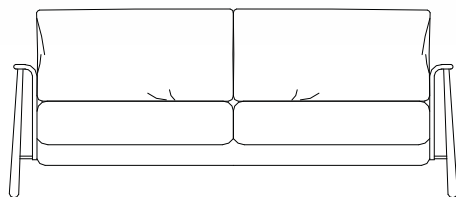

— B —

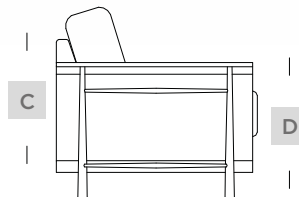

MH 4236									
LUGARES	BRAÇOS	A		B		C		D	
Nº	Nº	CM	POL.	CM	POL.	CM	POL.	CM	POL.
4	2	228	89"	85	33"	88	34"	46	18"
3		188	74"						
Poltrona		109	42"						

A - largura | B - profundidade | C - altura | D - altura do assento



MH 4237

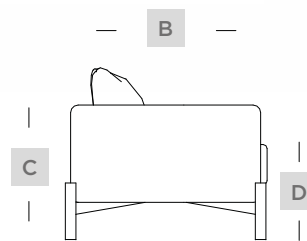
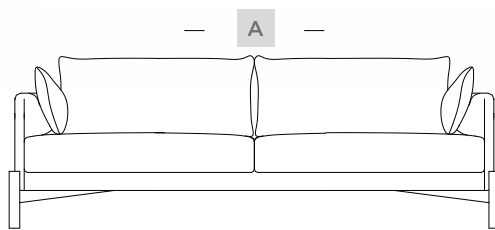

MH 4237											
LUGARES		BRAÇOS	PÉS	A		B		C		D	
Nº	TIPO	Nº	TIPO	CM	POL.	CM	POL.	CM	POL.	CM	POL.
4	Bipartido	2	Quadrados	276	108"	87	34"	87	34"	46	18"
			Redondos	278	109"						
3	-		Quadrados	236	92"						
			Redondos	238	93"						
2	-		Quadrados	206	81"						
			Redondos	208	81"						
Poltrona	-		Quadrados	111	43"						
			Redondos	113	44"						

A - largura | B - profundidade | C - altura | D - altura do assento



MH 4032







MH 4032



ELEGANT  
ELEGANTE

# ELE GAN TE



MH 4032

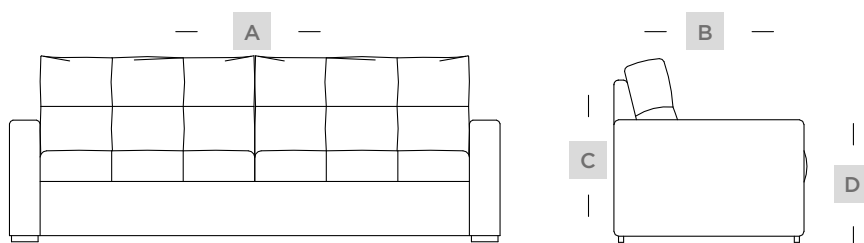

MH 4032										
LUGARES	BRAÇOS		A		B		C		D	
N°	N°	TIPO	CM	POL.	CM	POL.	CM	POL.	CM	POL.
4	2	Reto	240	94"	93	36"	91	35"	45	17"
3	2	Almofada	212	83"						
	1		178	70"						
2	2	Almofada	162	63"						
	1		128	50"						
3	2	Reto	183	72"						
	1		166	65"						
2	2	Reto	133	52"						
	1		116	45"						
Chaise longue	1	Almofada	108	42"						
	1	Reto	92	36"						
Canto	-	-	90	36"	90	36"				

A - largura | B - profundidade | C - altura | D - altura do assento



MH 4032





MH 4130

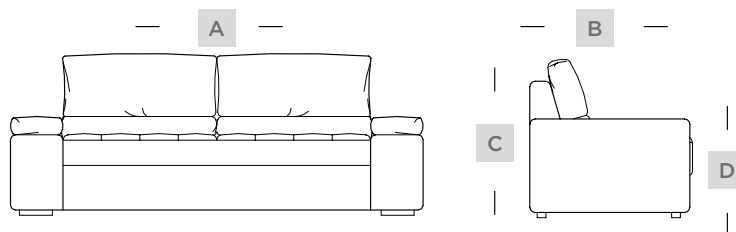

MH 4130										
LUGARES	BRAÇOS		A		B		C		D	
Nº	Nº	TIPO	CM	POL.	CM	POL.	CM	POL.	CM	POL.
3	2	Almofada	233	91"	93	36"	91	35"	46	18"
		Reto	223	87"						
3	1	Almofada	203	79"						
		Reto	198	77"						
3	-	-	175	68"						
2	2	Almofada	183	72"						
		Reto	173	68"						
2	1	Almofada	153	60"						
		Reto	148	58"						
2	-	-	123	48"						
Chaise longue	1	Almofada	118	46"	148	58"				
		Reto	113	44"						
Chaise longue baú	1	Almofada	118	46"						
		Reto	113	44"						
Canto	-	-	90	35"	90	35"				

A - largura | B - profundidade | C - altura | D - altura do assento | Veja mais opções deste modelo, em sofá cama, nas páginas 76 e 77.



MH 4130





MH 4192

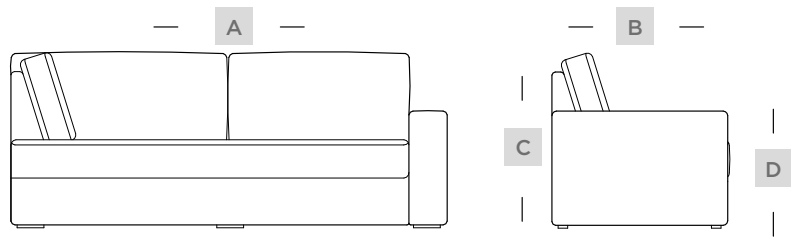

MH 4192											
TIPO	BRAÇOS		ASSENTO	A		B		C		D	
Nº	Nº	LARGURA (CM)	CM	CM	POL.	CM	POL.	CM	POL.	CM	POL.
Canto (3 lug.)	1	-	-	228	90"	93	36"	91	35"	46	18"
Chaise longue	-	-	-	147	57"	93	36"	91	35"	46	18"
Canto	-	-	-	93	36"	93	36"	91	35"	46	18"
Módulo	1	20	120	140	55"	93	36"	91	35"	46	18"
			110	130	51"						
			100	120	47"						
			90	110	43"						
			70	90	35"						
Módulo	1	10	120	130	51"	93	36"	91	35"	46	18"
			110	120	47"						
			100	110	43"						
			90	100	39"						
			70	80	31"						
Módulo	-	-	120	120	47"	93	36"	91	35"	46	18"
			110	110	43"						
			100	100	39"						
			90	90	35"						
			70	70	27"						

A - largura | B - profundidade | C - altura | D - altura do assento



MH 4192



# CLÁS SÍ CO



MH 4194

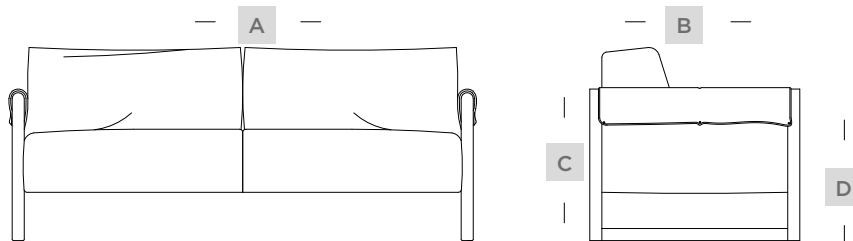

MH 4194									
LUGARES	BRAÇOS	A		B		C		D	
Nº	Nº	CM	POL.	CM	POL.	CM	POL.	CM	POL.
3	2	191	75"	87	34"	88	35"	46	18"
Poltrona		80	31"						

A - largura | B - profundidade | C - altura | D - altura do assento





MH 4203

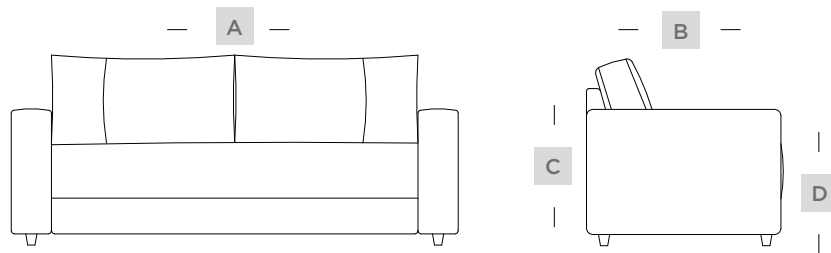

MH 4203									
LUGARES	BRAÇOS	A		B		C		D	
Nº	Nº	CM	POL.	CM	POL.	CM	POL.	CM	POL.
4 Bipartido	2	246	96"	87	34"	85	33"	46	18"
3,5		230	90"						
3		200	78"						
2		138	54"						
3	1	184	72"						
Chaise longue	1	101	39"	145	57"	85	33"	46	18"
Banqueta	-	58	22"	48	18"	40	15"	40	15"

A - largura | B - profundidade | C - altura | D - altura do assento



MH 4229

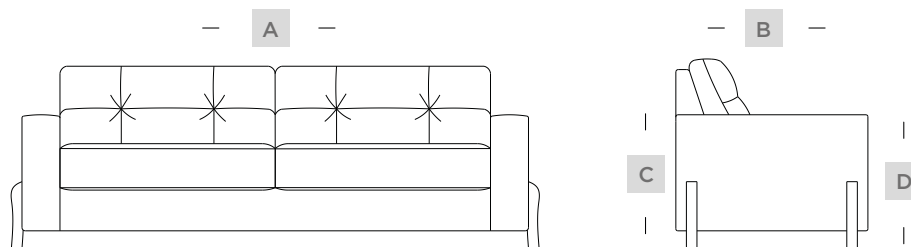

MH 4229									
LUGARES	BRAÇOS	A		B		C		D	
Nº	Nº	CM	POL.	CM	POL.	CM	POL.	CM	POL.
4	2	254	100"	91	35"	88	34"	46	18"
3,5		227	89"						
3		198	77"						
3	1	174	68"	148	58"				
Poltrona	2	105	41"						
Chaise Longue	1	99	38"						

A - largura | B - profundidade | C - altura | D - altura do assento



MH 4168

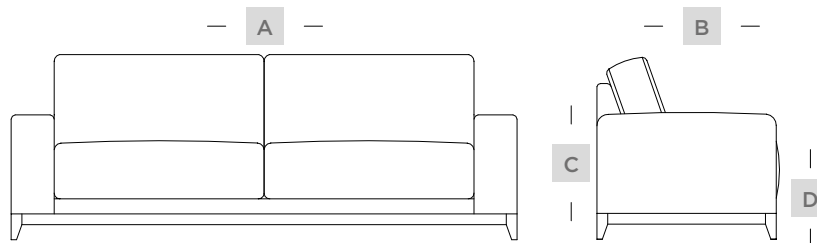

MH 4168									
LUGARES	BRAÇOS	A		B		C		D	
Nº	Nº	CM	POL.	CM	POL.	CM	POL.	CM	POL.
4	2	235	93"	86	34"	86	34"	46	18"
3		195	77"						
2		155	61"						

A - largura | B - profundidade | C - altura | D - altura do assento



MH 4187

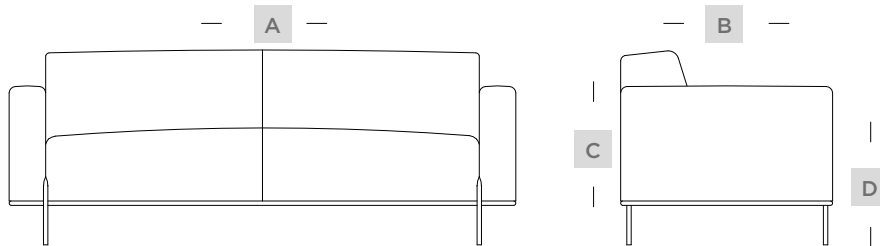

MH 4187									
LUGARES	BRAÇOS	A		B		C		D	
Nº	Nº	CM	POL.	CM	POL.	CM	POL.	CM	POL.
3	2	208	81"	89	35"	80	31"	48	18"
A - largura   B - profundidade   C - altura   D - altura do assento									



MH 4209

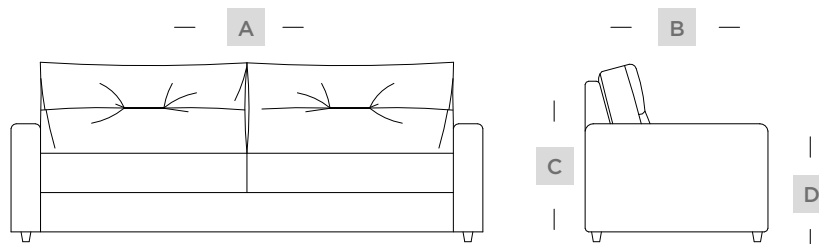

MH 4209									
LUGARES	BRAÇOS	A		B		C		D	
Nº	Nº	CM	POL.	CM	POL.	CM	POL.	CM	POL.
4	2	240	94"	93	36"	91	35"	45	17"
3,5		213	83"						
3		183	72"						
2		133	52"						

A - largura | B - profundidade | C - altura | D - altura do assento



MH 4210

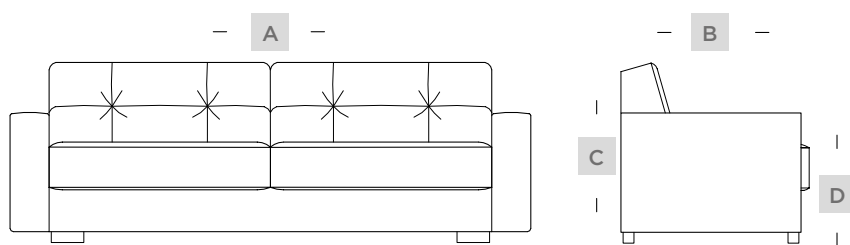

MH 4210									
LUGARES	BRAÇOS	A		B		C		D	
N°	N°	CM	POL.	CM	POL.	CM	POL.	CM	POL.
4	2	240	94"	88	36"	84	33"	46	17"
3		210	82"						
2		180	70"						
2	1	165	64"						
Chaise longue	1	91	35"	150	59"				
A - largura   B - profundidade   C - altura   D - altura do assento									



MH 4219

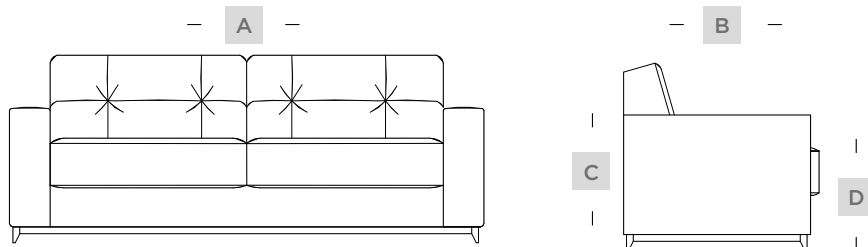

MH 4219										
LUGARES		BRAÇOS	A		B		C		D	
Nº	TIPO	Nº	CM	POL.	CM	POL.	CM	POL.	CM	POL.
4	Bipartido	2	262	103"	88	34"	84	33"	46	16"
	-		240	94"						
3	-	2	210	82"						
		1	193	75"						
2	-	2	180	70"						
		1	163	64"						
		2	158	62"						
Chaise	-	1	108	42"	146	57"				
Poltrona	-	2	96	37"	88	34"				

A - largura | B - profundidade | C - altura | D - altura do assento



MH 4225

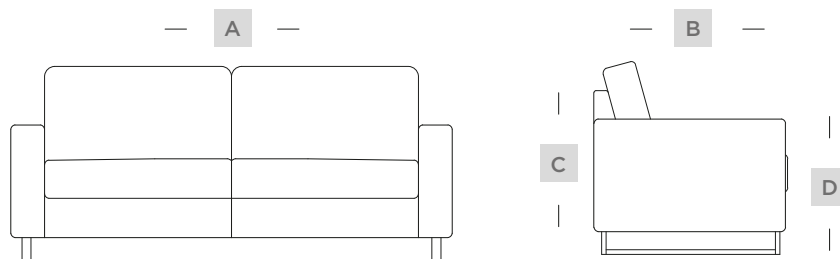

MH 4225									
LUGARES	BRAÇOS	A		B		C		D	
Nº	Nº	CM	POL.	CM	POL.	CM	POL.	CM	POL.
4	2	226	88"	86	33"	84	33"	45	17"
3		196	77"						
2,5		166	65"						
A - largura   B - profundidade   C - altura   D - altura do assento									





MH 4226

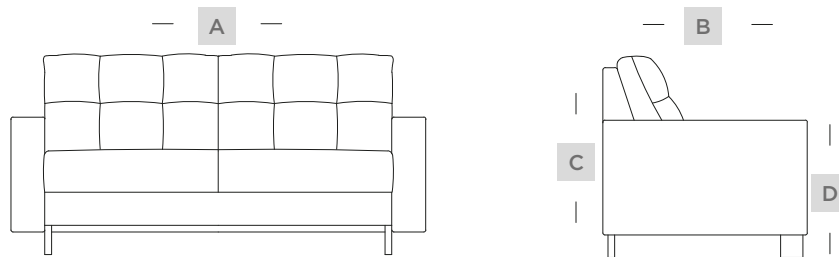

MH 4226									
LUGARES	BRAÇOS	A		B		C		D	
Nº	Nº	CM	POL.	CM	POL.	CM	POL.	CM	POL.
4	2	240	94"	91	35"	88	34"	46	18"
3,5		213	83"						
3		184	72"						
Poltrona		91	35"						

A - largura | B - profundidade | C - altura | D - altura do assento



MH 4227

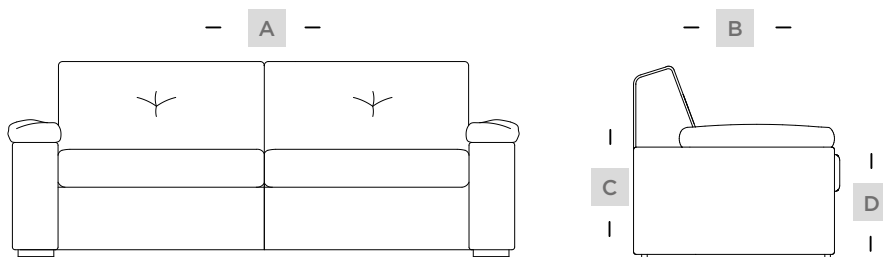

MH 4227									
LUGARES	BRAÇOS	A		B		C		D	
Nº	Nº	CM	POL.	CM	POL.	CM	POL.	CM	POL.
4	2	252	99"	88	34"	84	33"	46	18"
3		222	87"						
2		192	75"						

A - largura | B - profundidade | C - altura | D - altura do assento



MH 4227



# ESTILO

STYLE  
ESTILO



MH 4242





MH 4242

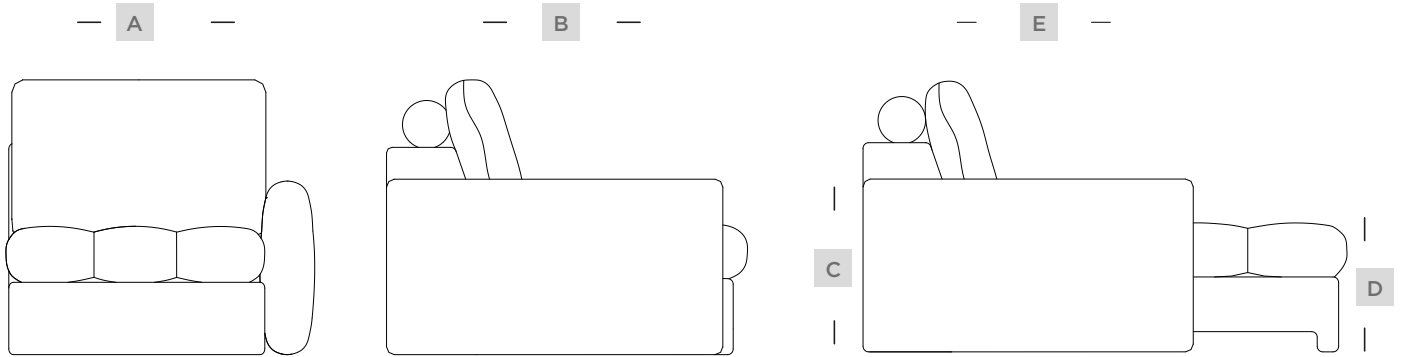

MH 4242											
LUGARES	BRAÇOS	A		B		C		D		E	
Nº	Nº	CM	POL.	CM	POL.	CM	POL.	CM	POL.	CM	POL.
Chaise Longue	-	93	36"	122	48"	93	36"	47	18"	170	66"
	1	109	42"								
	-	103	40"								
	1	119	46"								
	-	113	44"								
	1	129	50"								

A - largura | B - profundidade | C - altura | D - altura do assento | E - profundidade aberto



MH 4248

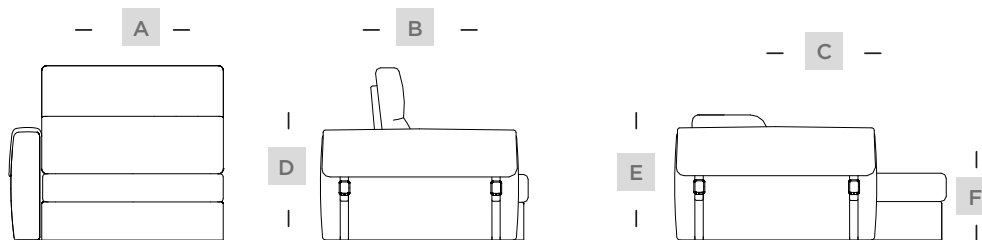

MH 4248															
MÓDULOS	BRAÇOS		ASSENTO	A		B		C		D		E		F	
	Nº	LARGURA (CM)	CM	CM	POL.	CM	POL.	CM	POL.	CM	POL.	CM	POL.	CM	POL.
RETRÁTIL	-	19	90	92	36"	118	46"	167	65"	95	37"	81	31"	46	18"
	1			111	43"										
	-			102	40"										
	1		100	121	47"										
	-		110	112	44"										
	1			131	51"										
	-			120	122										
	1		141		55"										

A - largura | B - profundidade | C - profundidade aberta | D - altura | E - altura reclinado | F - altura do assento



MH 4248





MH 4108

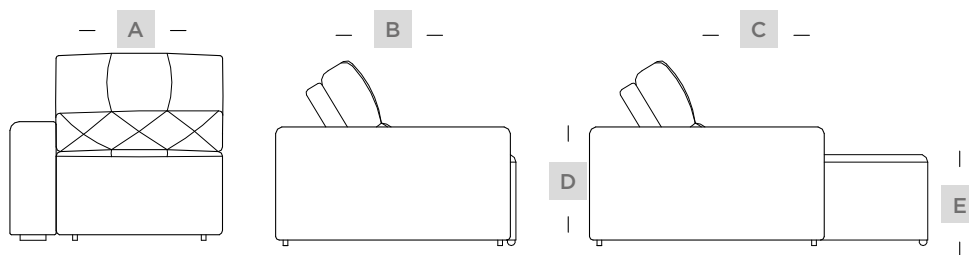

MH 4108														
MÓDULOS	BRAÇOS		ASSENTO		A		B		C		D		E	
	Nº	LARGURA (CM)	CM	CM	POL.	CM	POL.	CM	POL.	CM	POL.	CM	POL.	
Chaise retrátil	-	-	90	91	35"									
			100	101	39"									
			110	111	43"									
Chaise retrátil	1	18	90	108	42"	130	51"	183	72"	91	35"	48	18"	
			100	118	46"									
			110	128	50"									
Chaise retrátil	1	25	90	115	45"	130	51"	183	72"	91	35"	48	18"	
			100	125	49"									
			110	135	53"									
Chaise retrátil	1	35	90	125	49"	130	51"	183	72"	91	35"	48	18"	
			100	135	53"									
			110	145	57"									

A - largura | B - profundidade | C - profundidade aberta | D - altura | E - altura do assento





MH 4179

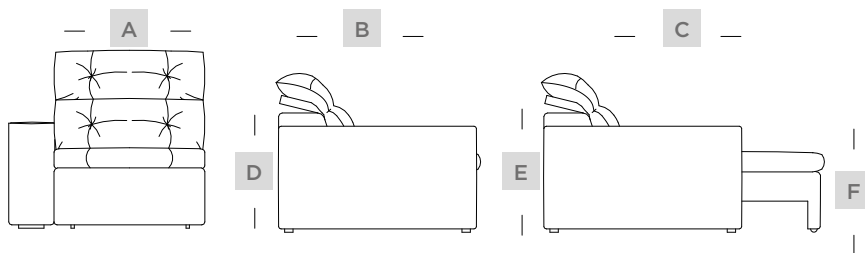

MH 4179															
MÓDULOS	BRAÇOS		ASSENTO	A		B		C		D		E		F	
	Nº	LARGURA (CM)	CM	CM	POL.	CM	POL.	CM	POL.	CM	POL.	CM	POL.	CM	POL.
Chaise retrátil	-	-	90	92	36"	123	48"	170	66"	102	40"	88	35"	48	19"
	1	20		112	44"										
		25		117	46"										
Chaise retrátil	-	-	100	102	40"	123	48"	170	66"	102	40"	88	35"	48	19"
	1	20		122	48"										
		25		127	50"										
Chaise retrátil	-	-	110	112	44"	123	48"	170	66"	102	40"	88	35"	48	19"
	1	20		132	51"										
		25		137	53"										

A - largura | B - profundidade | C - profundidade aberta | D - altura | E - altura reclinado | F - altura do assento



MH 4212

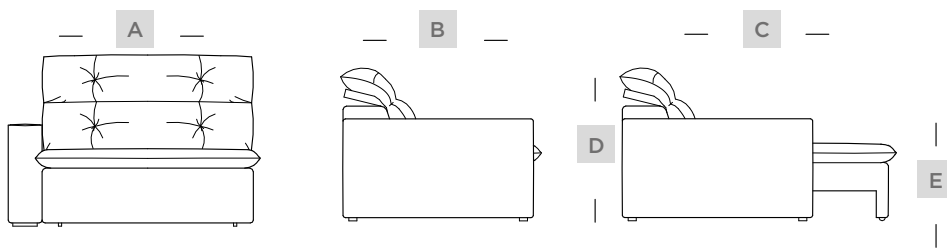

MH 4212												
MÓDULOS	BRAÇOS	ASSENTO	A		B		C		D		E	
	N°	CM	CM	POL.	CM	POL.	CM	POL.	CM	POL.	CM	POL.
Chaise retrátil	1	90	111	43"	123	48"	170	66"	105	41"	46	18"
		110	131	51"								
Chaise retrátil	-	90	91	35"	123	48"	170	66"	105	41"	46	18"
		110	111	43"								

A - largura | B - profundidade | C - profundidade aberta | D - altura | E - altura do assento



MH 4212





MH 4185

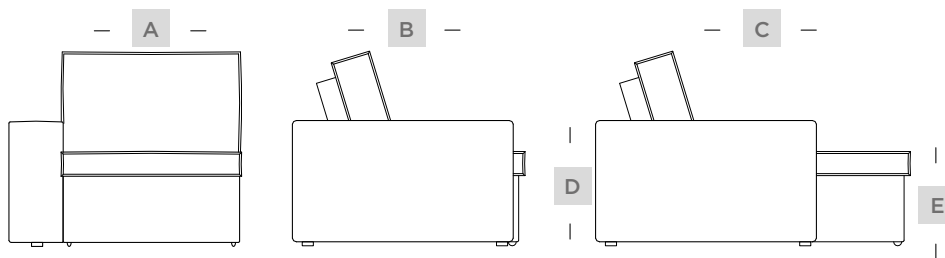

MH 4185													
MÓDULOS	BRAÇOS		ASSENTO	A		B		C		D		E	
	Nº	LARGURA (CM)	CM	CM	POL.	CM	POL.	CM	POL.	CM	POL.	CM	POL.
Chaise retrátil	-	-	90	90	35"	116	45"	157	61"	97	38"	47	18"
	1	18		108	42"								
		25		115	45"								
Chaise retrátil	-	-	100	100	39"	116	45"	157	61"	97	38"	47	18"
	1	18		118	46"								
		25		125	49"								
Chaise retrátil	-	-	110	110	43"	116	45"	157	61"	97	38"	47	18"
	1	18		128	50"								
		25		135	53"								

A - largura | B - profundidade | C - profundidade aberta | D - altura | E - altura do assento



MH 4211

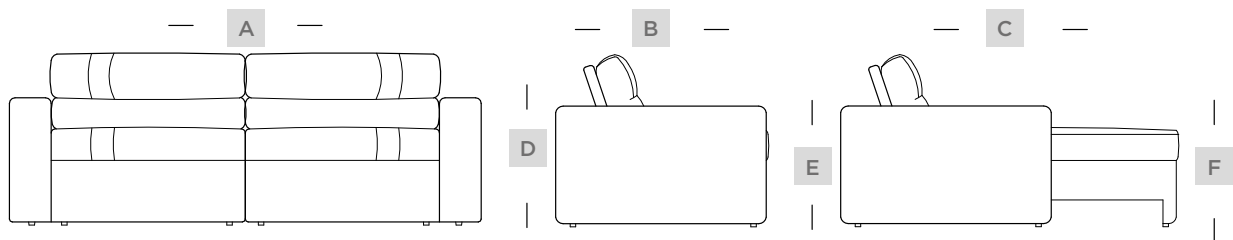

MH 4211														
MÓDULOS	BRAÇOS	ASSENTO			B		C		D		E		F	
	Nº	CM	CM	POL.	CM	POL.	CM	POL.	CM	POL.	CM	POL.	CM	POL.
3 lugares retrátil	2	160	205	80"	106	54"	162	54"	102	40"	82	32"	46	18"
Chaise retrátil	1	90	113	45"										
		110	133	53"										
Chaise retrátil	-	90	91	36"	106	54"	162	54"	102	40"	82	32"	46	18"
		110	111	44"										

A - largura | B - profundidade | C - profundidade aberta | D - altura | E - altura reclinado | F - altura do assento



MH 4011



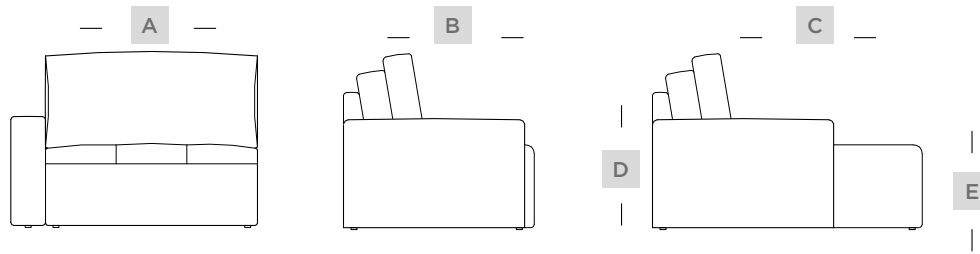

MH 4011														
MÓDULOS	BRAÇOS		ASSENTO	A			B		C		D		E	
N°	N°	LARGURA (CM)	CM	CM	POL..	CM	POL..	CM	POL..	CM	POL..	CM	POL..	
Chaise retrátil	-	-	70	71	27"	99	38"	140	55"	91	35"	43	16"	
			80	81	31"									
			90	92	36"									
			100	101	39"									
			110	111	43"									
1	1	12	70	83	32"	99	38"	140	55"	91	35"	43	16"	
			80	93	36"									
			90	103	40"									
			100	113	44"									
			110	123	48"									
1	1	18	70	89	35"	99	38"	140	55"	91	35"	43	16"	
			80	99	38"									
			90	109	42"									
			100	119	46"									
			110	129	50"									
1	1	25	70	96	37"	99	38"	140	55"	91	35"	43	16"	
			80	106	41"									
			90	116	45"									
			100	126	49"									
			110	136	53"									
1	2	12	70	95	37"	99	38"	140	55"	91	35"	43	16"	
			80	105	41"									
			90	115	44"									
			100	125	49"									
			110	135	53"									
1	2	18	70	107	42"	99	38"	140	55"	91	35"	43	16"	
			80	117	46"									
			90	127	49"									
			100	137	53"									
			110	147	57"									
1	2	25	70	121	47"	99	38"	140	55"	91	35"	43	16"	
			80	131	51"									
			90	141	55"									
			100	151	59"									
			110	161	63"									

A - largura | B - profundidade | C - profundidade aberta | D - altura | E - altura do assento



MH 4214

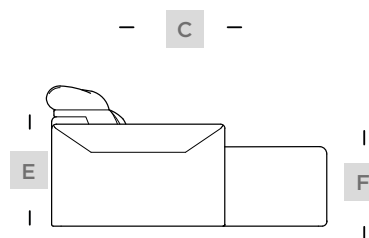
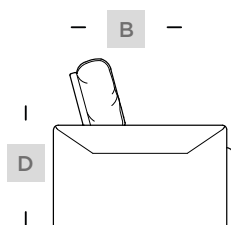
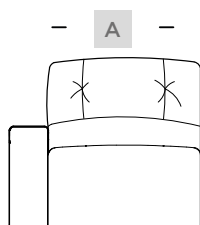

MH 4214														
MÓDULOS	BRAÇOS	ASSENTO	A		B		C		D		E		F	
	N°	CM	CM	POL.	CM	POL.	CM	POL.	CM	POL.	CM	POL.	CM	POL.
3 lugares retrátil	2	162	205	80"										
Chaise retrátil	1	90	113	45"	106	42"	162	54"	102	40"	82	32"	46	18"
		110	133	53"										
Chaise retrátil	-	90	91	36"										
		110	111	44"										

A - largura | B - profundidade | C - profundidade aberta | D - altura | E - altura reclinado | F - altura do assento





MH 4215

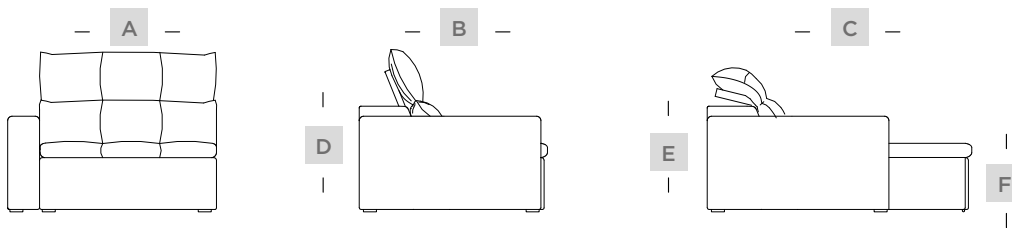

MH 4215														
MÓDULOS	BRAÇOS	ASSENTO	A		B		C		D		E		F	
	N°	CM	CM	POL.	CM	POL.	CM	POL.	CM	POL.	CM	POL.	CM	POL.
Chaise retrátil	1	90	111	43"	118	51"	166	65"	104	40"	92	36"	46	18"
		110	131	51"										
Chaise retrátil	-	90	91	35"	118	51"	166	65"	104	40"	92	36"	46	18"
		110	111	43"										

A - largura | B - profundidade | C - profundidade aberta | D - altura | E - altura reclinado | F - altura do assento



MH 4220

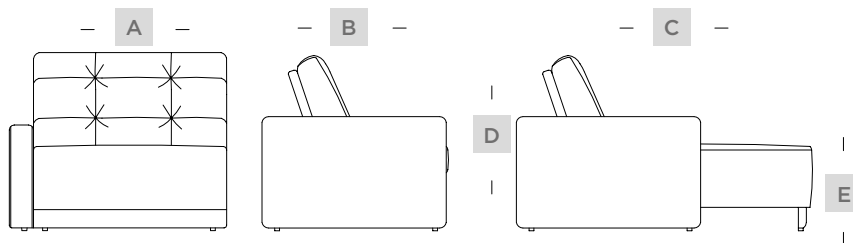

MH 4220												
MÓDULOS	BRAÇOS	ASSENTO	A		B		C		D		E	
	Nº	CM	CM	POL.	CM	POL.	CM	POL.	CM	POL.	CM	POL.
Chaise retrátil	-	90	90	35"	117	46"	158	62"	96	37"	46	18"
	1		99	38"								
	-	100	100	39"								
	1		109	42"								
	-	110	110	43"								
	1		119	47"								
	-	120	120	47"								
	1		129	50"								

A - largura | B - profundidade | C - profundidade aberta | D - altura | E - altura do assento



MH 4221

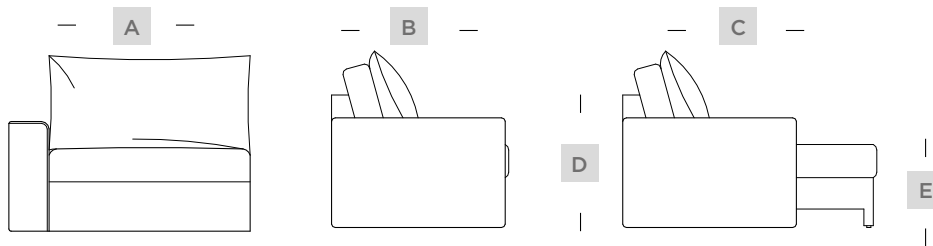

MH 4221														
MÓDULOS	BRAÇOS		ASSENTO		A		B		C		D		E	
	Nº	LARGURA (CM)	CM	CM	POL.	CM	POL.	CM	POL.	CM	POL.	CM	POL.	
Chaise retrátil	-	-	80	82	32"	98	38"	139	54"	96	37"	45	17"	
			90	92	36"									
			100	102	40"									
			110	112	44"									
Chaise retrátil	1	12	80	94	37"	98	38"	139	54"	96	37"	45	17"	
			90	104	40"									
			100	114	44"									
			110	124	48"									
Chaise retrátil	1	20	80	102	40"	98	38"	139	54"	96	37"	45	17"	
			90	112	44"									
			100	122	48"									
			110	132	51"									

A - largura | B - profundidade | C - profundidade aberta | D - altura | E - altura do assento



MH 4191

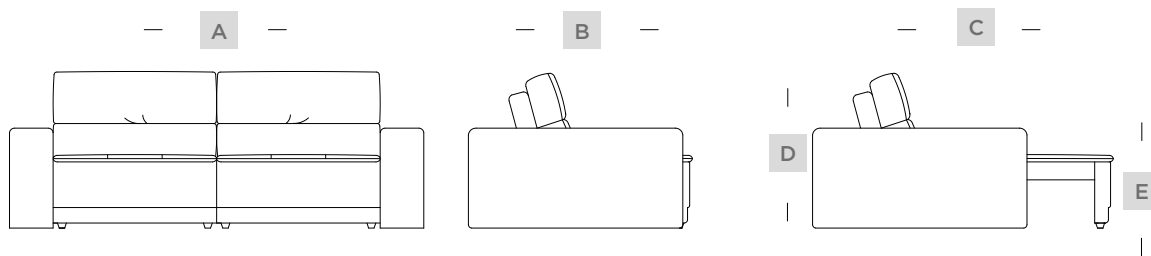

MH 4191													
LUGARES	BRAÇOS		ASSENTO	A		B		C		D		E	
N°	N°	LARGURA (CM)	CM	CM	POL.	CM	POL.	CM	POL.	CM	POL.	CM	POL.
3 - retrátil	2	25	90	228	89"	118	46"	164	64"	98	38"	46	18"

A - largura | B - profundidade | C - profundidade aberta | D - altura | E - altura do assento



MH 4191



# PRÁ TI CO

PRACTICAL  
PRÁCTICO



MH 3809



— A —

— B —

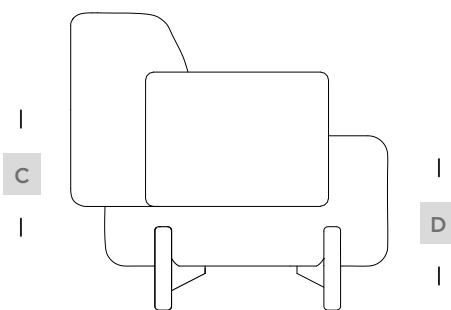
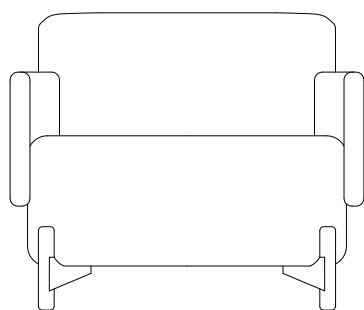

MH 3809									
LUGARES	BRAÇOS	A		B		C		D	
Nº	Nº	CM	POL.	CM	POL.	CM	POL.	CM	POL.
Poltrona	-	80	31"	80	31"	78	30"	44	17"
Poltrona	2	90	35"						

A - largura | B - profundidade | C - altura | D - altura do assento



MH 3814

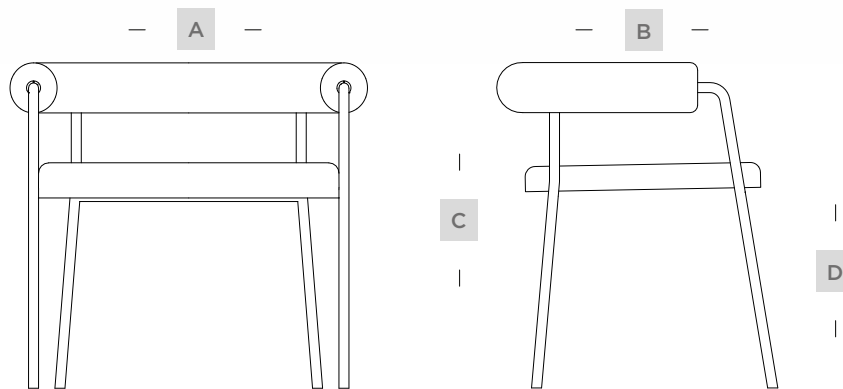

MH 3814									
LUGARES	BRAÇOS	A		B		C		D	
N°	N°	CM	POL.	CM	POL.	CM	POL.	CM	POL.
Poltrona	2	73	29"	62	24"	67	26"	46	18"
A - largura   B - profundidade   C - altura   D - altura do assento									



MH 3815

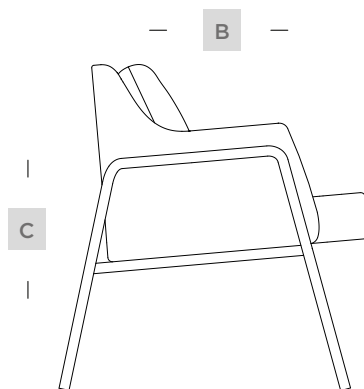
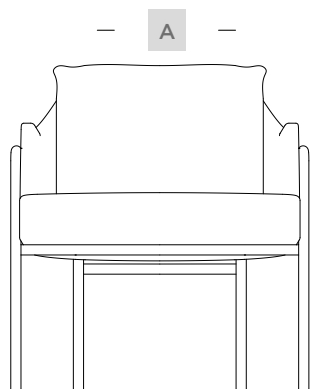

MH 3815									
LUGARES	BRAÇOS	A		B		C		D	
Nº	Nº	CM	POL.	CM	POL.	CM	POL.	CM	POL.
Poltrona	2	66	25"	73	28"	73	28"	44	17"
A - largura   B - profundidade   C - altura   D - altura do assento									





MH 3807

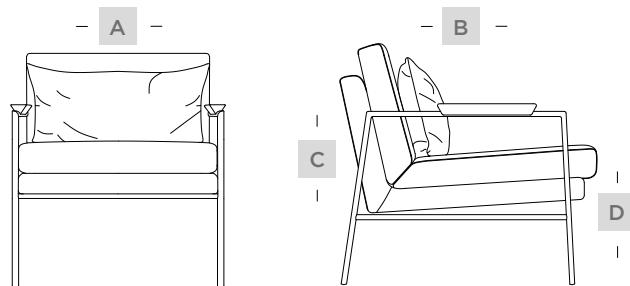

MH 3807									
LUGARES	BRAÇOS	A		B		C		D	
Nº	Nº	CM	POL.	CM	POL.	CM	POL.	CM	POL.
Poltrona	2	70	27"	86	33"	79	31"	48	18"
A - largura   B - profundidade   C - altura   D - altura do assento									



MH 3817

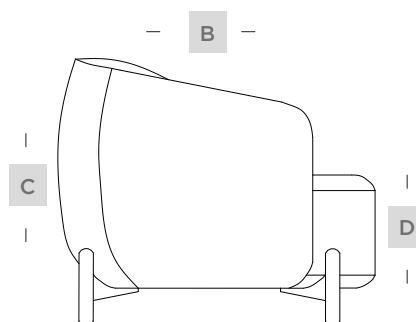
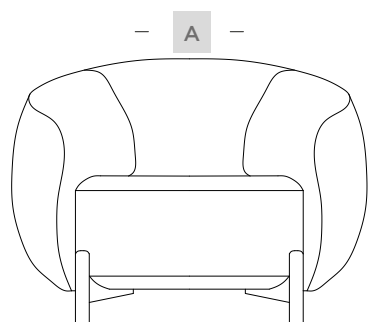

MH 3817									
LUGARES	BRAÇOS	A		B		C		D	
Nº	Nº	CM	POL.	CM	POL.	CM	POL.	CM	POL.
Poltrona	2	101	39"	89	35"	76	29"	47	18"
A - largura   B - profundidade   C - altura   D - altura do assento									



MH 3817



# CHAR MO SO

CHARMING  
ENCANTADOR

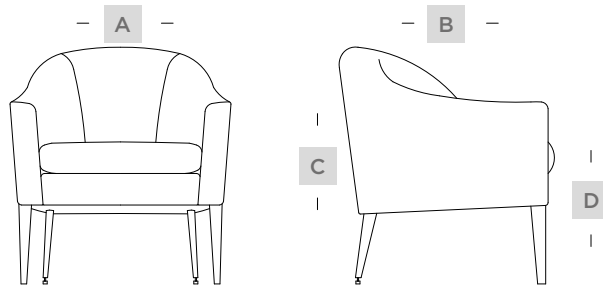

MH 1235									
LUGARES	BRAÇOS	A		B		C		D	
Nº	Nº	CM	POL.	CM	POL.	CM	POL.	CM	POL.
Poltrona	2	70	27"	69	27"	75	29"	45	17"
A - largura   B - profundidade   C - altura   D - altura do assento									

MH 1235





MH 3685

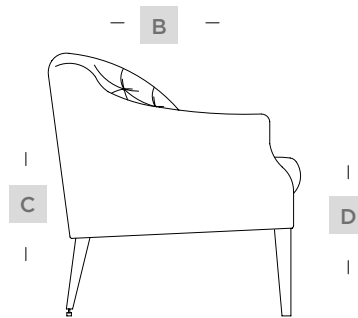
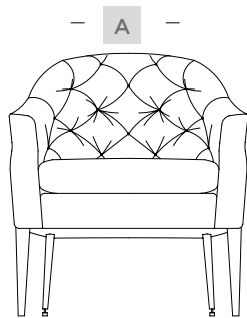

MH 3685									
LUGARES	BRAÇOS	A		B		C		D	
N°	N°	CM	POL.	CM	POL.	CM	POL.	CM	POL.
Poltrona	2	70	27"	72	28"	78	30"	45	17"
A - largura   B - profundidade   C - altura   D - altura do assento									

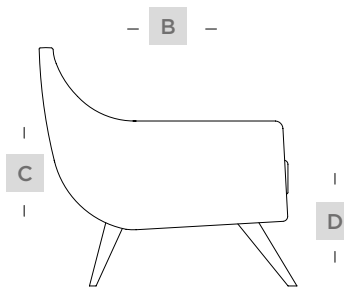
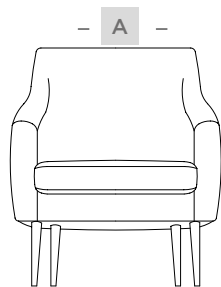

MH 3747									
LUGARES	BRAÇOS	A		B		C		D	
N°	N°	CM	POL.	CM	POL.	CM	POL.	CM	POL.
Poltrona	2	78	30"	92	36"	88	34"	46	18"
A - largura   B - profundidade   C - altura   D - altura do assento									

MH 3747





MH 3783

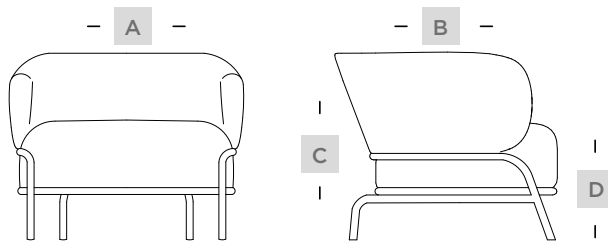

MH 3783									
LUGARES	BRAÇOS	A		B		C		D	
N°	N°	CM	POL.	CM	POL.	CM	POL.	CM	POL.
Poltrona	2	80	32"	76	29"	75	29"	45	18"
A - largura   B - profundidade   C - altura   D - altura do assento									

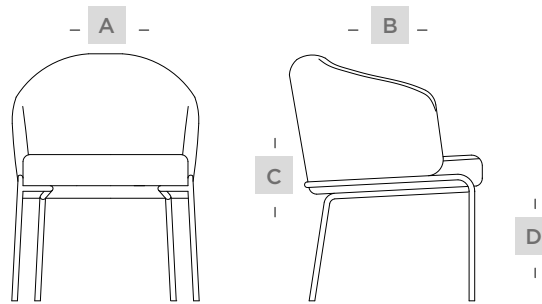

MH 3784									
LUGARES	BRAÇOS	A		B		C		D	
N°	N°	CM	POL.	CM	POL.	CM	POL.	CM	POL.
Poltrona	2	60	23"	62	24"	79	31"	47	18"
A - largura   B - profundidade   C - altura   D - altura do assento									

MH 3784







MH 3785

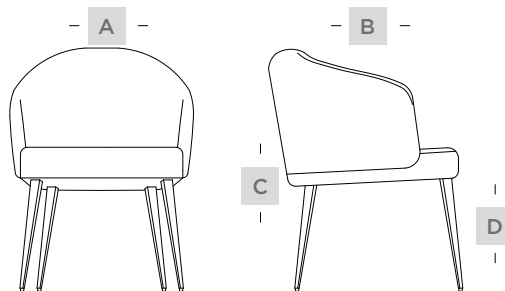

MH 3785									
LUGARES	BRAÇOS	A		B		C		D	
N°	N°	CM	POL.	CM	POL.	CM	POL.	CM	POL.
Poltrona	2	60	23"	62	24"	79	31"	47	18"
A - largura   B - profundidade   C - altura   D - altura do assento									

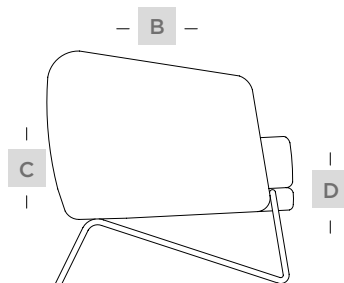
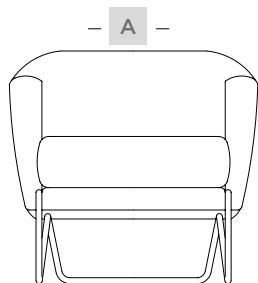

MH 3788									
LUGARES	BRAÇOS	A		B		C		D	
N°	N°	CM	POL.	CM	POL.	CM	POL.	CM	POL.
Poltrona	2	76	29"	77	30"	73	28"	45	17"
A - largura   B - profundidade   C - altura   D - altura do assento									

MH 3788





MH 3789

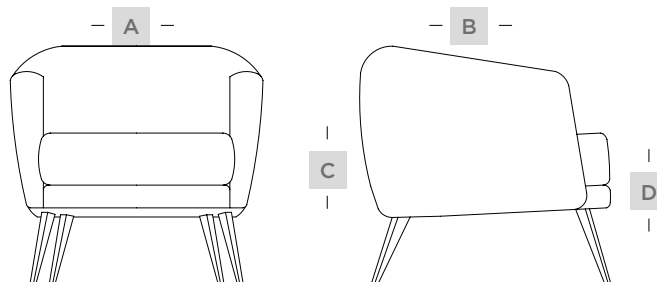

MH 3789									
LUGARES	BRAÇOS	A		B		C		D	
Nº	Nº	CM	POL.	CM	POL.	CM	POL.	CM	POL.
Poltrona	2	76	29"	77	30"	73	28"	45	17"
A - largura   B - profundidade   C - altura   D - altura do assento									

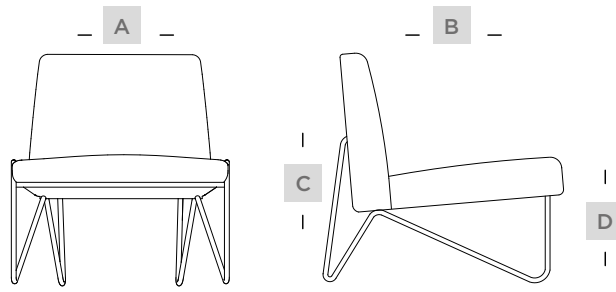

MH 3795								
LUGARES	A		B		C		D	
N°	CM	POL.	CM	POL.	CM	POL.	CM	POL.
Poltrona	73	34"	70	34"	77	34"	47	34"
A - largura   B - profundidade   C - altura   D - altura do assento								

MH 3795





MH 3801

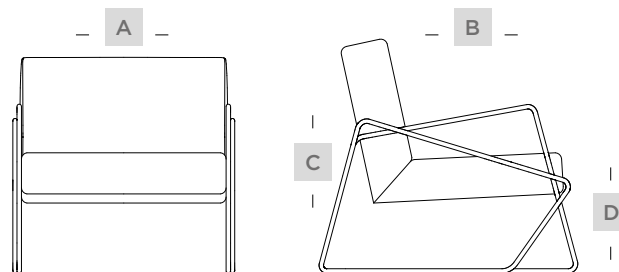

MH 3801									
LUGARES	BRAÇOS	A		B		C		D	
N°	N°	CM	POL.	CM	POL.	CM	POL.	CM	POL.
Poltrona	2	76	29"	83	32"	78	30"	47	18"
A - largura   B - profundidade   C - altura   D - altura do assento									

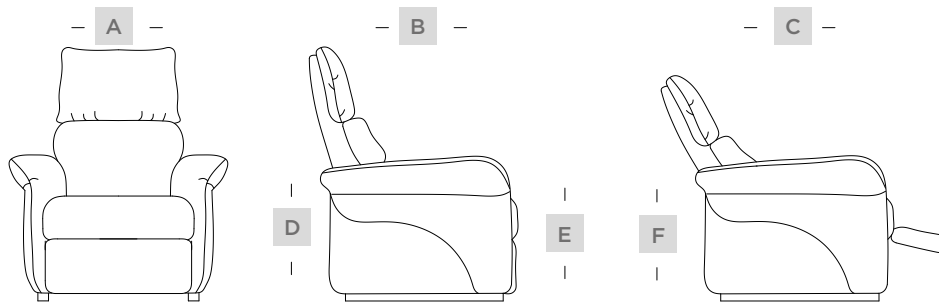

MH 3816													
LUGARES	BRAÇOS	A		B		C		D		E		F	
Nº	Nº	CM	POL.	CM	POL.	CM	POL.	CM	POL.	CM	POL.	CM	POL.
Poltrona	2	82	32"	92	36"	150	59"	105	41"	48	18"	82	32"
A - largura   B - profundidade   C - profundidade aberta   D - altura   E - altura do assento   F - altura reclinado													

MH 3816





MH 1217

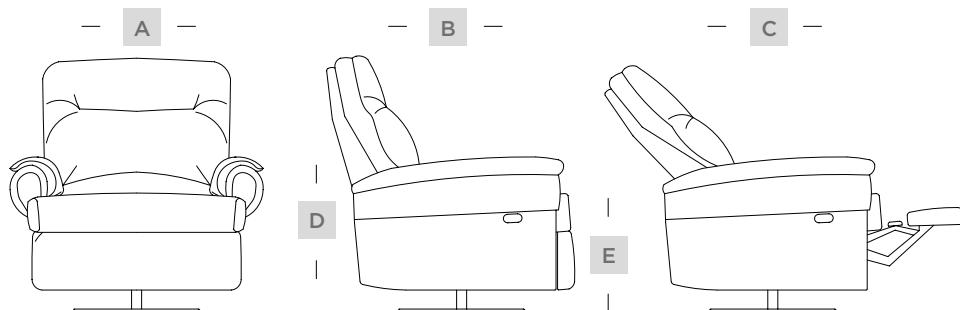

MH 1217											
LUGARES	BRAÇOS	A		B		C		D		E	
N°	N°	CM	POL.	CM	POL.	CM	POL.	CM	POL.	CM	POL.
Poltrona	2	101	39"	98	38"	144	56"	101	39"	48	18"
A - largura   B - profundidade   C - profundidade aberta   D - altura   E - altura do assento											



MH 3678

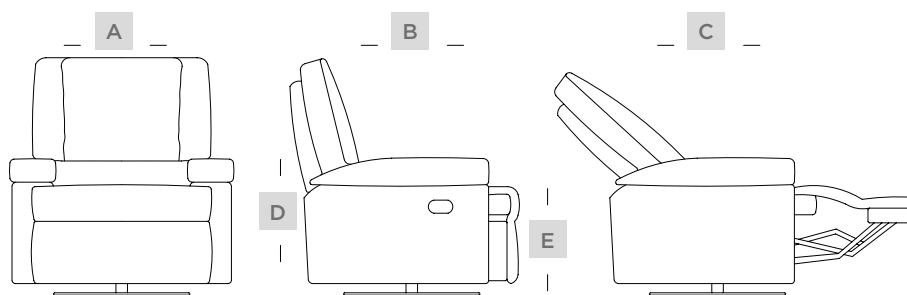

MH 3678											
LUGARES	BRAÇOS	A		B		C		D		E	
Nº	Nº	CM	POL.	CM	POL.	CM	POL.	CM	POL.	CM	POL.
Poltrona	2	97	32"	99	38"	157	61"	103	40"	47	17"
A - largura   B - profundidade   C - profundidade aberta   D - altura   E - altura do assento											





MH 3678



# CON FOR TO

COMFORT  
COMODIDAD

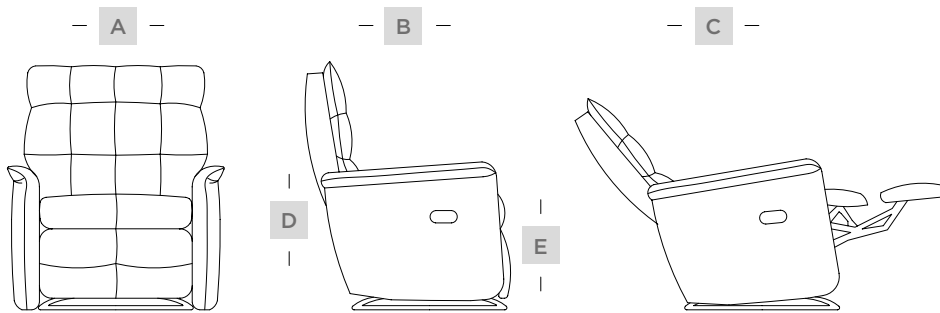

MH 3790											
LUGARES	BRAÇOS	A		B		C		D		E	
Nº	Nº	CM	POL.	CM	POL.	CM	POL.	CM	POL.	CM	POL.
Poltrona	2	90	35"	93	36"	160	52"	105	41"	50	19"
A - largura   B - profundidade   C - profundidade aberta   D - altura   E - altura do assento											

MH 3790





MH 3791

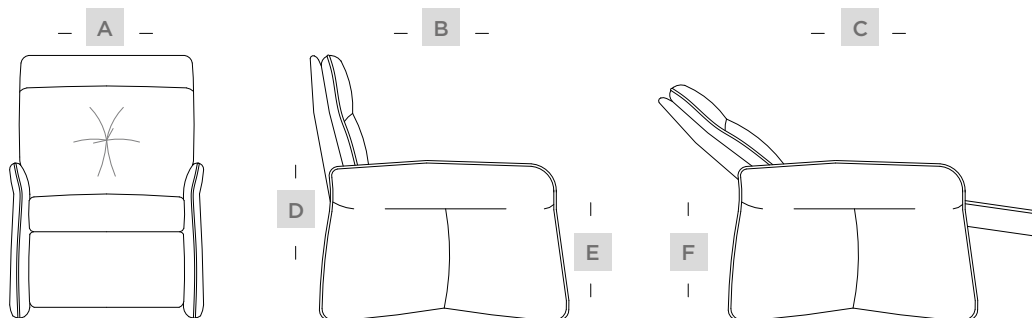

MH 3791													
LUGARES	BRAÇOS	A		B		C		D		E		F	
N°	N°	CM	POL.	CM	POL.	CM	POL.	CM	POL.	CM	POL.	CM	POL.
Poltrona	2	77	30"	93	36"	151	59"	105	41"	50	19"	90	35"
A - largura   B - profundidade   C - profundidade aberta   D - altura   E - altura do assento   F - altura reclinado													

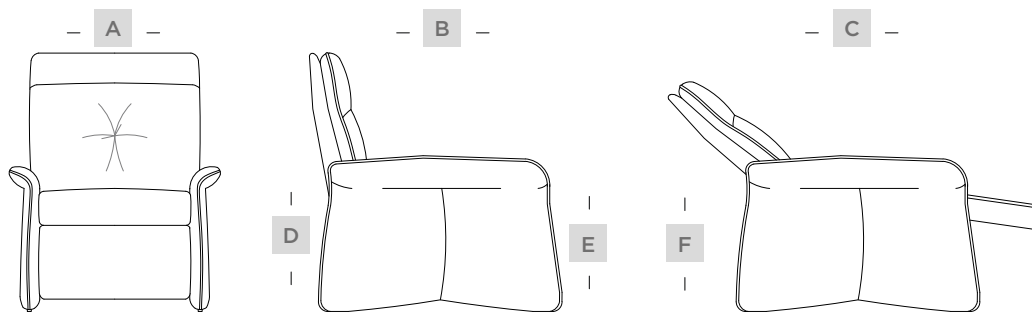

MH 3792													
LUGARES	BRAÇOS	A		B		C		D		E		F	
N°	N°	CM	POL.	CM	POL.	CM	POL.	CM	POL.	CM	POL.	CM	POL.
Poltrona	2	80	30"	97	38"	151	59"	105	41"	50	19"	90	35"
A - largura   B - profundidade   C - profundidade aberta   D - altura   E - altura do assento   F - altura reclinado													

MH 3792





MH 3808

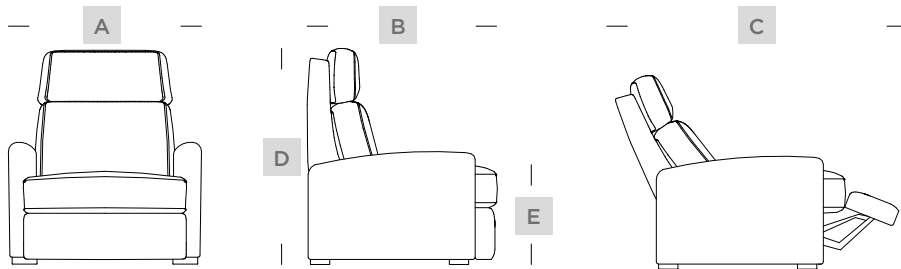

MH 3808											
LUGARES	BRAÇOS	A		B		C		D		E	
Nº	Nº	CM	POL.	CM	POL.	CM	POL.	CM	POL.	CM	POL.
Poltrona	2	86	33"	92	36"	153	60"	105	41"	48	18"
A - largura   B - profundidade   C - profundidade aberta   D - altura   E - altura do assento											

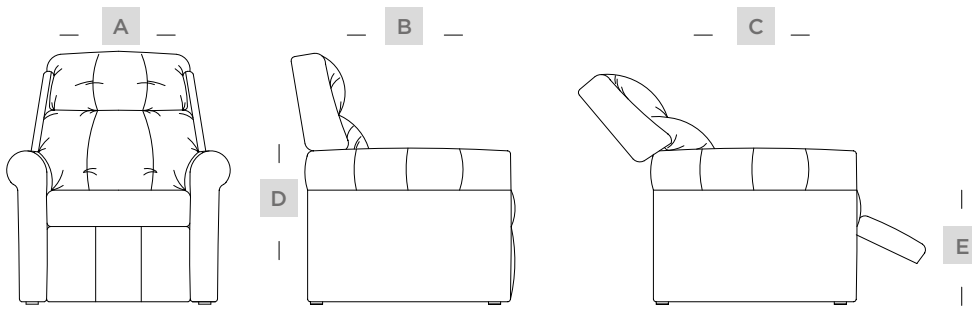

MH 1216											
LUGARES	BRAÇOS	A		B		C		D		E	
N°	N°	CM	POL.	CM	POL.	CM	POL.	CM	POL.	CM	POL.
Poltrona	2	89	35"	93	37"	149	59"	103	41"	47	18"
A - largura   B - profundidade   C - profundidade aberta   D - altura   E - altura do assento											

MH 1216





MH 1237

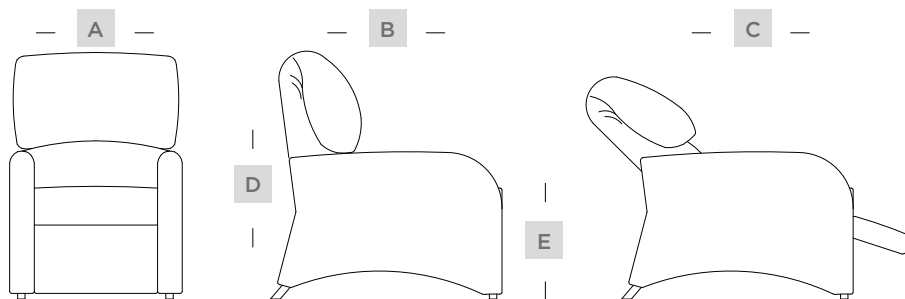

MH 1237											
LUGARES	BRAÇOS	A		B		C		D		E	
N°	N°	CM	POL.	CM	POL.	CM	POL.	CM	POL.	CM	POL.
Poltrona	2	70	27"	92	36"	147	57"	100	39"	45	17"
A - largura   B - profundidade   C - profundidade aberta   D - altura   E - altura do assento											

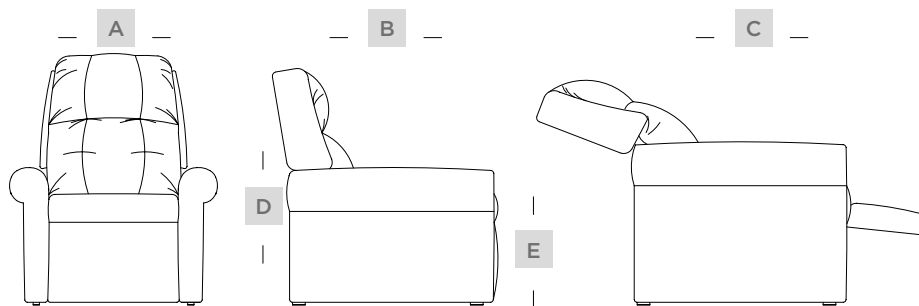

MH 3601											
LUGARES	BRAÇOS	A		B		C		D		E	
N°	N°	CM	POL.	CM	POL.	CM	POL.	CM	POL.	CM	POL.
Poltrona	2	82	32"	89	35"	154	60"	99	38"	44	17"
A - largura   B - profundidade   C - profundidade aberta   D - altura   E - altura do assento											

MH 3601







MH 3605

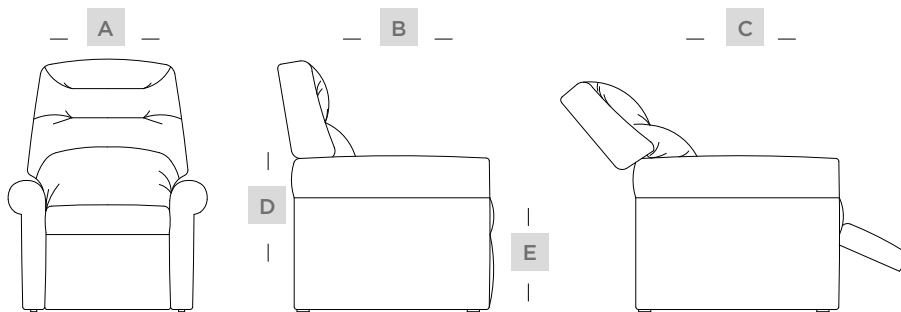

MH 3605											
LUGARES	BRAÇOS	A		B		C		D		E	
N°	N°	CM	POL.	CM	POL.	CM	POL.	CM	POL.	CM	POL.
Poltrona	2	82	32"	89	35"	154	60"	99	38"	44	17"
A - largura   B - profundidade   C - profundidade aberta   D - altura   E - altura do assento											



MH 6019

— A —

— B —

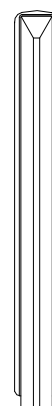
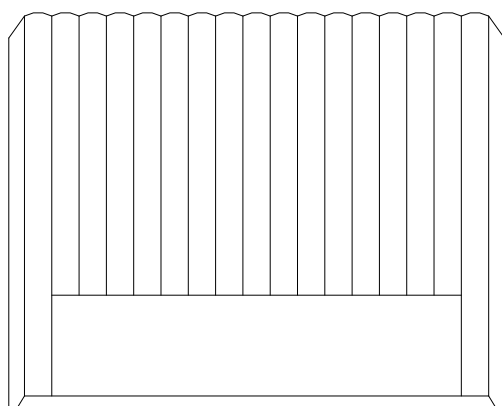

|  
C  
|

MH 6019						
TIPO	A		B		C	
	CM	POL.	CM	POL.	CM	POL.
Cabeceira 138	158	62"	12	4"	125	49"
Cabeceira 158	178	62"				
Cabeceira 193	213	83"				

A - largura | B - profundidade | C - altura



MH 6020

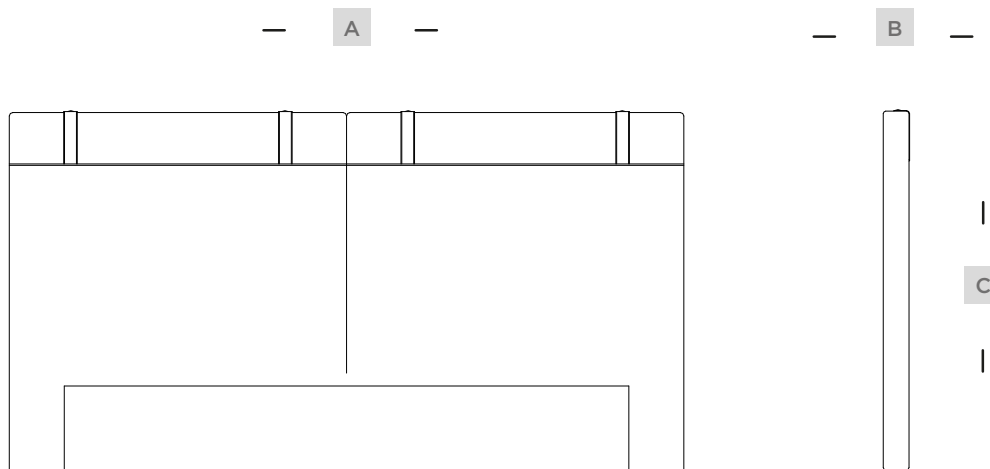

MH 6020						
TIPO	A		B		C	
	CM	POL.	CM	POL.	CM	POL.
Cabeceira 138	183	72"	90	3"	126,5	49"
Cabeceira 158	203	79"				
Cabeceira 193	238	93"				

A - largura | B - profundidade | C - altura

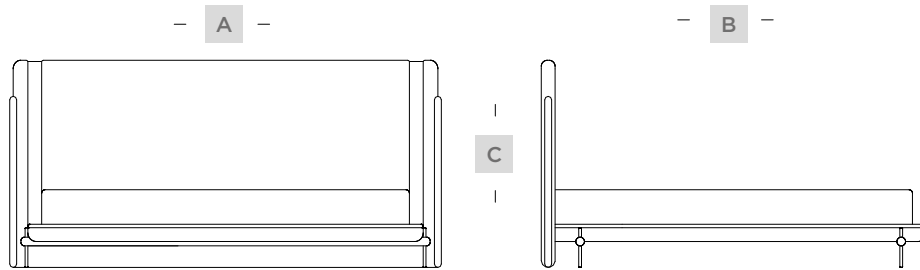

MH 6016						
TIPO	A		B		C	
	CM	POL.	CM	POL.	CM	POL.
Cama 138	195	76"	208	81"	117	46"
Cama 158	215	84"	218	85"		
Cama 193	250	98"	223	87"		

A - largura | B - profundidade | C - altura

MH 6016





MH 6017

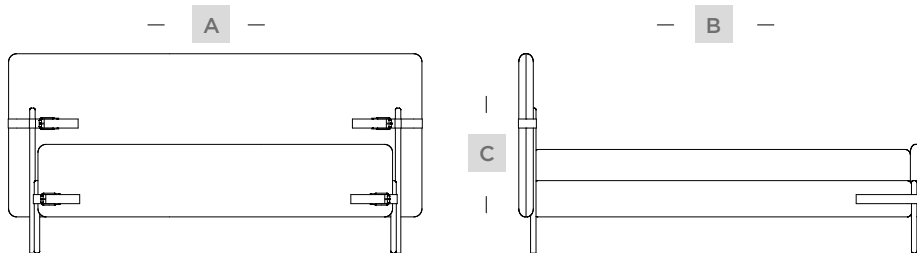

MH 6017						
TIPO	A		B		C	
	CM	POL.	CM	POL.	CM	POL.
Cama 138	174	68"	207	81"	102	40"
Cama 158	194	76"	217	85"		
Cama 193	229	90"	222	87"		

A - largura | B - profundidade | C - altura



MH 2651

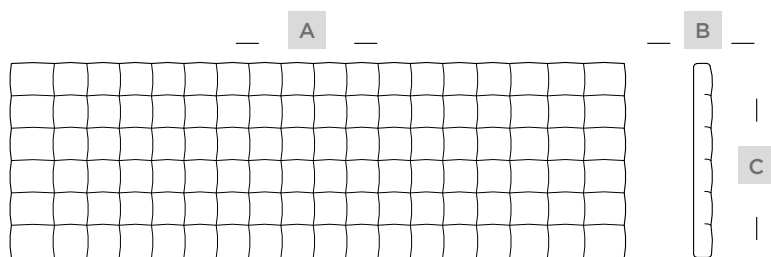

MH 2651						
TIPO	A		B		C	
	CM	POL.	CM	POL.	CM	POL.
Cabeceira 138	244	62"	13	5"	102	40"
Cabeceira 158	282	111"				
Cabeceira 193	322	126"				
Cabeceira 138	244	62"			122	48"
Cabeceira 158	282	111"				
Cabeceira 193	322	126"				

A - largura | B - profundidade | C - altura



01 - MH 2694 | 02 - MH 2696

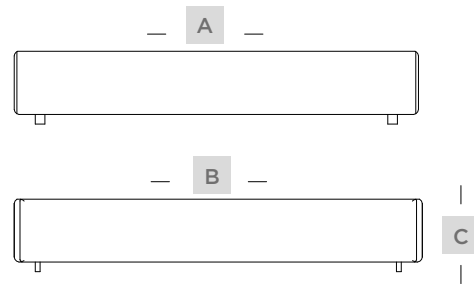
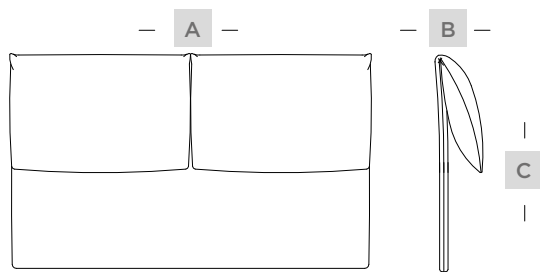

MH 2694						
TIPO	A		B		C	
	CM	POL.	CM	POL.	CM	POL.
Cabeceira 138	160	56"	30	11"	130	48"
Cabeceira 158	180	64"				
Cabeceira 193	215	77"				

A - largura | B - profundidade | C - altura

MH 2696						
TIPO	A		B		C	
	CM	POL.	CM	POL.	CM	POL.
Cama 138	150	59"	197	77"	38	14"
Cama 158	170	66"	207	81"		
Cama 193	210	82"	212	83"		

A - largura | B - profundidade | C - altura



MH 2690

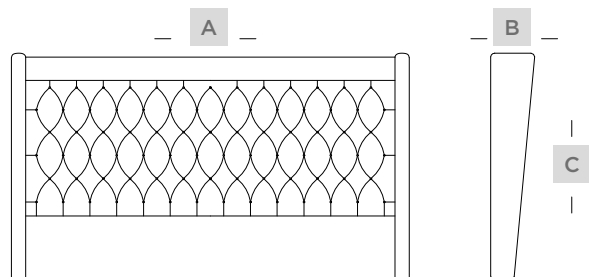

MH 2690						
TIPO	A		B		C	
	CM	POL.	CM	POL.	CM	POL.
Cabeceira 138	168	66"	27	10"	126	49"
Cabeceira 158	188	74"				
Cabeceira 193	223	87"				

A - largura | B - profundidade | C - altura





MH 6014

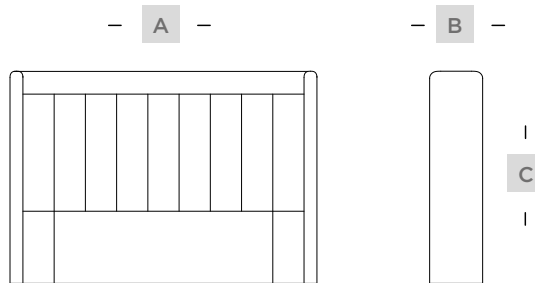

MH 6014						
TIPO	A		B		C	
	CM	POL.	CM	POL.	CM	POL.
Cabeceira 138	167	65"	26	10"	125	49"
Cabeceira 158	187	73"				
Cabeceira 193	222	87"				

A - largura | B - profundidade | C - altura



MH 2650

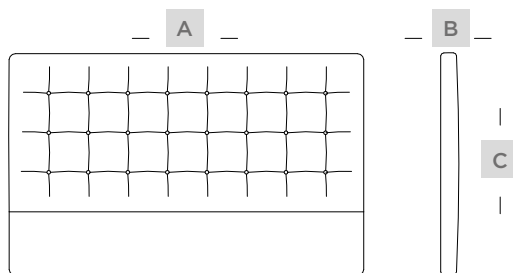

MH 2650						
TIPO	A		B		C	
	CM	POL.	CM	POL.	CM	POL.
Cabeceira 88	90	35"	10	3"	122	48"
Cabeceira 95	97	38"				
Cabeceira 138	140	55"				
Cabeceira 158	160	62"				
Cabeceira 193	195	76"				

A - largura | B - profundidade | C - altura



MH 2680

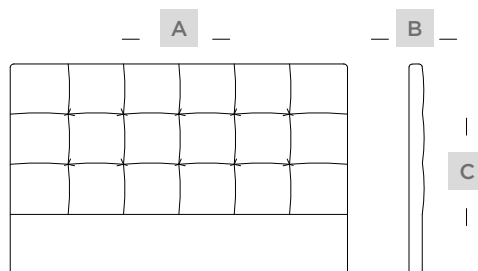

MH 2680						
TIPO	A		B		C	
	CM	POL.	CM	POL.	CM	POL.
Cabeceira 138	140	55"	10	3"	122	48"
Cabeceira 158	160	62"				
Cabeceira 193	195	76"				

A - largura | B - profundidade | C - altura



MH 6007

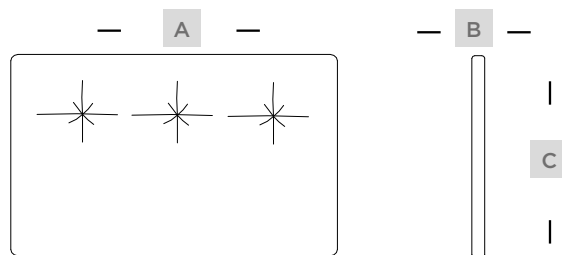

MH 6007						
TIPO	A		B		C	
	CM	POL.	CM	POL.	CM	POL.
Cabeceira 88	93	36"	10	3"	120	47"
Cabeceira 138	143	56"				
Cabeceira 158	163	64"				
Cabeceira 193	198	77"				
A - largura   B - profundidade   C - altura						



MH 6008

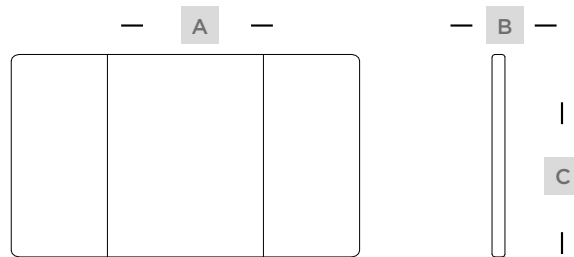

MH 6008						
TIPO	A		B		C	
	CM	POL.	CM	POL.	CM	POL.
Cabeceira 88	93	36"	10	3"	120	47"
Cabeceira 138	143	56"				
Cabeceira 158	163	64"				
Cabeceira 193	198	77"				
A - largura   B - profundidade   C - altura						



MH 1174

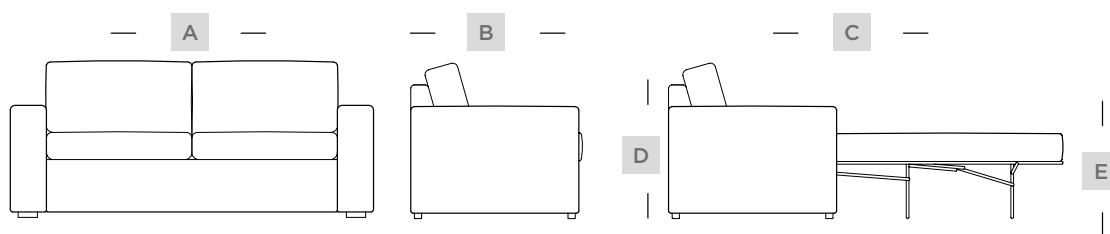

MH 1174												
TIPO	BRAÇOS		A		B		C		D		E	
	N°	LARGURA (CM)	CM	POL.	CM	POL.	CM	POL.	CM	POL.	CM	POL.
Sofá cama	2	25	201	78"	95	37"	226	89"	86	34"	47	18"
	2	17	185	73"								
	-	-	151	59"								

A - largura | B - profundidade | C - profundidade aberta | D - altura | E - altura do assento

01



02



01 - MH 1456 | 02 - MH 1496

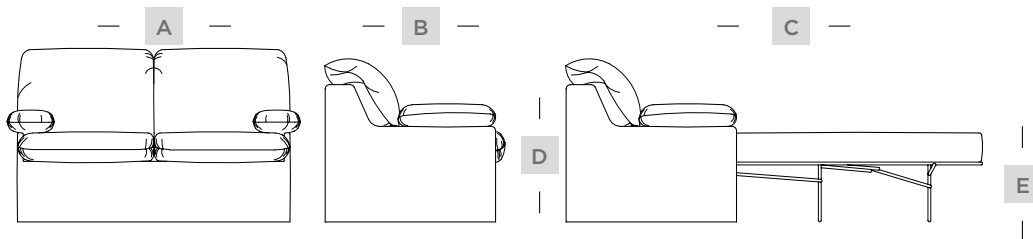

MH 1456											
TIPO	BRAÇOS	A		B		C		D		E	
	N°	CM	POL.	CM	POL.	CM	POL.	CM	POL.	CM	POL.
Sofá cama casal	2	155	61"	95	37"	220	87"	91	36"	47	18"
Sofá cama solteiro		105	41"								

A - largura | B - profundidade | C - profundidade aberta | D - altura | E - altura do assento

MH 1496											
TIPO	BRAÇOS	A		B		C		D		E	
	N°	CM	POL.	CM	POL.	CM	POL.	CM	POL.	CM	POL.
Sofá cama casal	2	155	61"	95	37"	220	87"	91	36"	47	18"
Sofá cama solteiro		105	41"								

A - largura | B - profundidade | C - profundidade aberta | D - altura | E - altura do assento



MH 1605

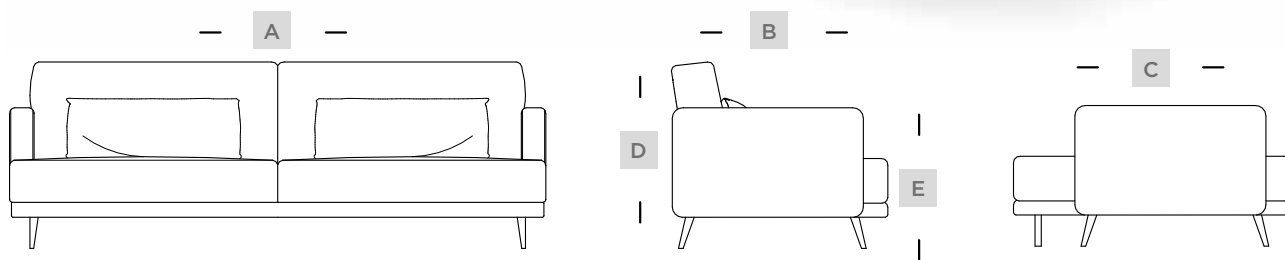

MH 1605												
TIPO	BRAÇOS		A		B		C		D		E	
	Nº	CM	POL.	CM	POL.	CM	POL.	CM	POL.	CM	POL.	
Sofá cama	2	211	83"	92	36"	120	47"	90	77"	45	17"	
A - largura   B - profundidade   C - profundidade aberta   D - altura   E - altura do assento												





MH 1606

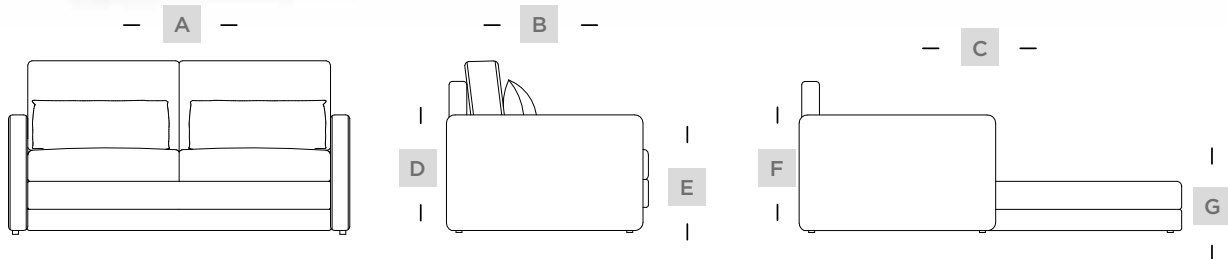

MH 1606															
TIPO	BRAÇOS	A		B		C		D		E		F		G	
		N°	CM	POL.	CM	POL.	CM	POL.	CM	POL.	CM	POL.	CM	POL.	
Sofá cama 146	2	146	57"	102	40"	194	76"	88	34"	44	17"	75	29"	29	17"
Sofá cama 176		176	69"												

A - largura | B - profundidade | C - profundidade aberta | D - altura | E - altura do assento | F - altura aberto | G - altura do assento aberto



MH 1609

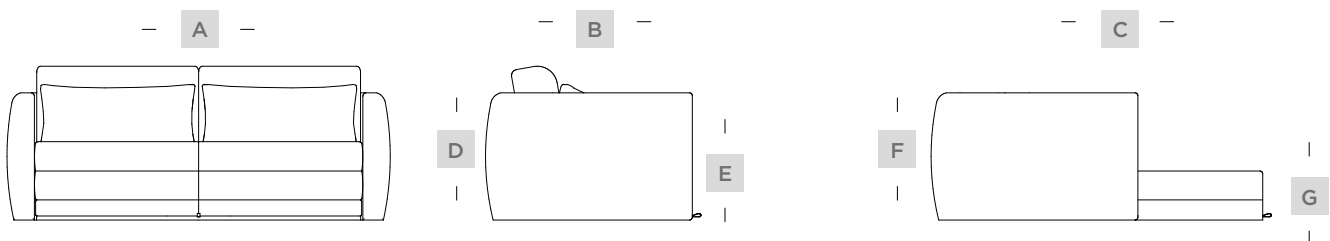

MH 1609															
TIPO	BRAÇOS	A		B		C		D		E		F		G	
		N°	CM	POL.	CM	POL.	CM	POL.	CM	POL.	CM	POL.	CM	POL.	CM
Sofá cama 128	2	158	62"	109	42"	202	79"	84	33"	44	17"	70	27"	30	11"
Sofá cama 158		188	74"												

A - largura | B - profundidade | C - profundidade aberta | D - altura | E - altura do assento | F - altura do encosto aberto | G - altura do assento aberto



MH 1610

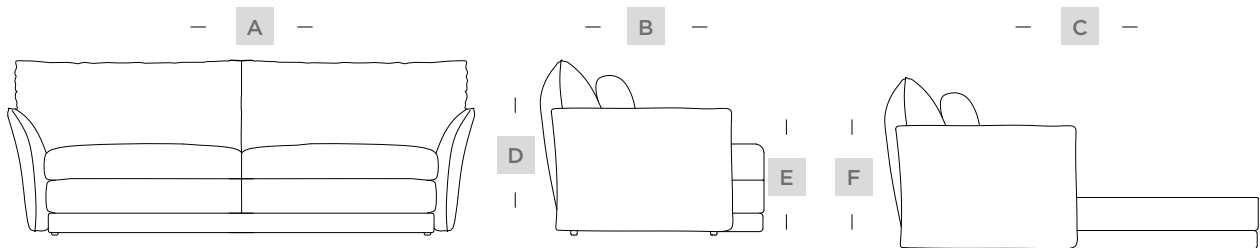

MH 1610													
TIPO	BRAÇOS	A		B		C		D		E		F	
		N°	CM	POL.	CM	POL.	CM	POL.	CM	POL.	CM	POL.	CM
Sofá cama	2	215	84"	103	40"	172	67"	86	33"	45	17"	80	31"
A - largura   B - profundidade   C - profundidade aberta   D - altura   E - altura do assento   F - altura do encosto aberto													



MH 4130





MH 4130

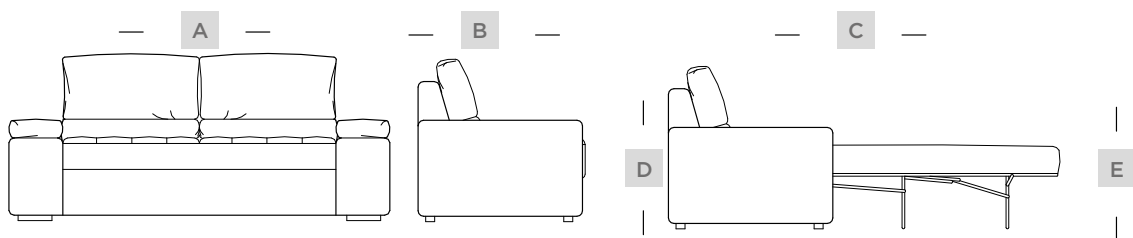

MH 4130												
TIPO	BRAÇOS		A		B		C		D		E	
	Nº	TIPO	CM	POL.	CM	POL.	CM	POL.	CM	POL.	CM	POL.
Sofá cama	2	Almofadas	212	83"	93	36"	218	85"	91	35"	46	18"
		Retos	202	79"								
	1	Almofada	182	71"								
		Reto	177	69"								
-	-	152	59"									

A - largura | B - profundidade | C - profundidade aberta | D - altura | E - altura do assento | Veja mais opções deste modelo, nas páginas 56 e 57.

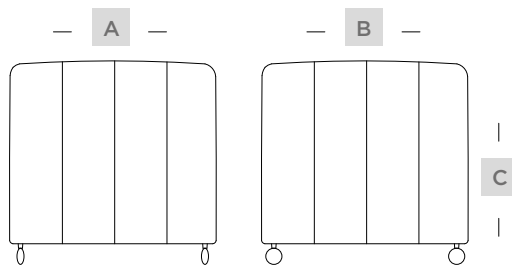

MH 3721							
TIPO	PÉS	A		B		C	
	Nº	CM	POL.	CM	POL.	CM	POL.
Puff	Com rodízios	45	17"	45	17"	45	17"
Puff	Fixos					42	16"

A - largura | B - profundidade | C - altura

MH 3721





MH 3722

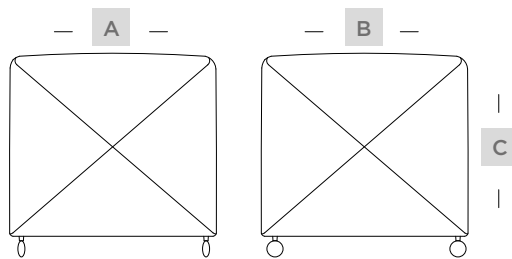

MH 3722							
TIPO	PÉS	A		B		C	
	Nº	CM	POL.	CM	POL.	CM	POL.
Puff	Com rodízios	45	17"	45	17"	45	17"
Puff						42	16"

A - largura | B - profundidade | C - altura

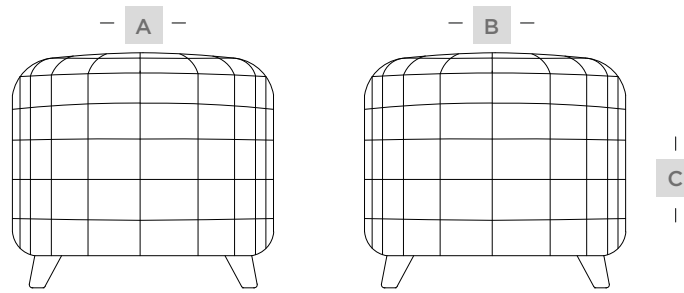

MH 9811					
A		B		C	
CM	POL.	CM	POL.	CM	POL.
50	19"	50	19"	45	17"
A - largura   B - profundidade   C - altura					

MH 9811







MH 9812

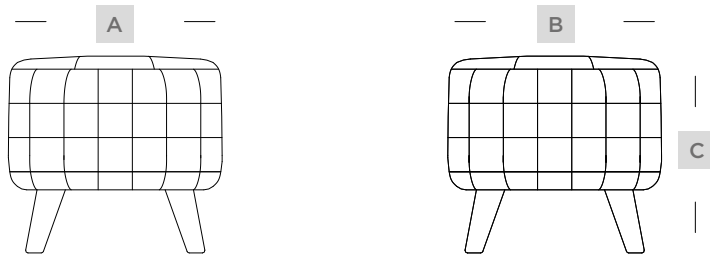

MH 9812					
A		B		C	
CM	POL.	CM	POL.	CM	POL.
50	19"	50	19"	45	17"
A - largura   B - profundidade   C - altura					

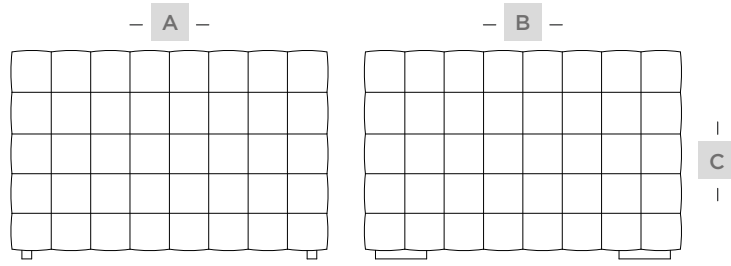

MH 9813					
A		B		C	
CM	POL.	CM	POL.	CM	POL.
65	25"	65	25"	43	16"
A - largura   B - profundidade   C - altura					

MH 9813





MH 9814

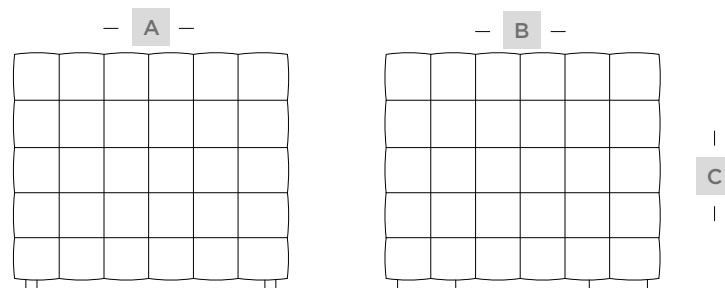

MH 9814					
A		B		C	
CM	POL.	CM	POL.	CM	POL.
50	19"	50	19"	43	16"
A - largura   B - profundidade   C - altura					

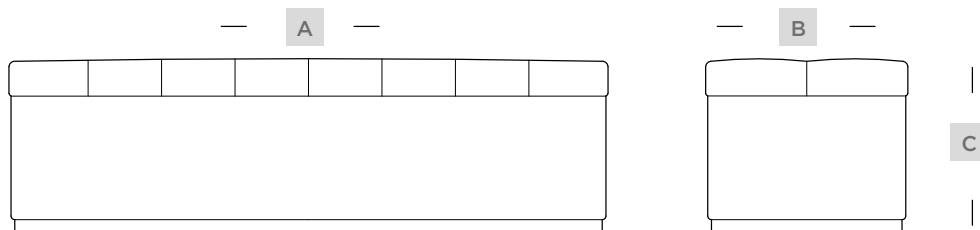

MH 3724						
TIPO	A		B		C	
	CM	POL.	CM	POL.	CM	POL.
Recamier baú	140	55"	54	21"	46	18"
Recamier baú	160	62"				

A - largura | B - profundidade | C - altura

MH 3724





01

Almofada decorativa 60 x 25 cm e 80 x 25 cm  
 Decorative pillow 60 x 25 cm y 80 x 25 cm  
 Almohada decorativa 60 x 25 cm y 80 x 25 cm



02

Almofada decorativa 56 x 40 cm  
 Decorative pillow 56 x 40 cm  
 Almohada decorativa 56 x 40 cm

01 - MH 7552 | 02 - MH 7584

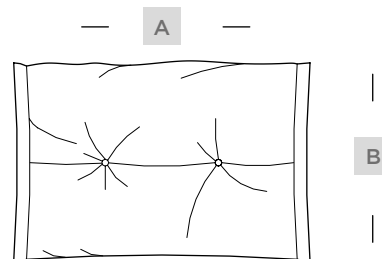
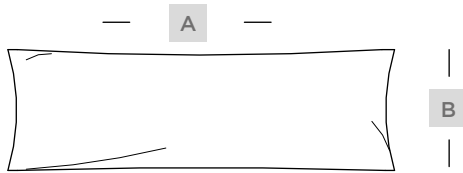

MH 7552				
TIPO	A		B	
	CM	POL.	CM	POL.
Almofada menor	60	23"	25	9"
Almofada maior	80	31"		
A - largura   B - altura				

MH 7584			
A		B	
CM	POL.	CM	POL.
56	22"	40	15"
A - largura   B - altura			

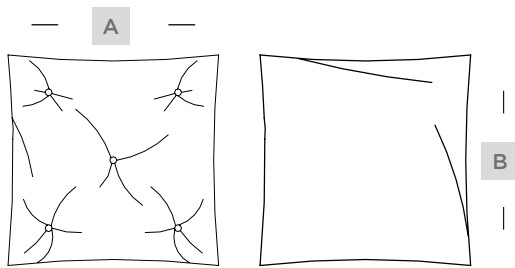

MH 7560			
A		B	
CM	POL.	CM	POL.
45	18"	45	18"
A - largura   B - profundidade			

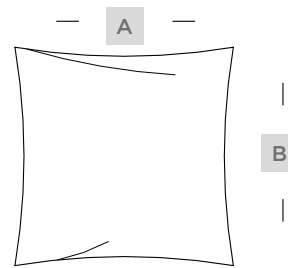

MH 7599			
A		B	
CM	POL.	CM	POL.
55	21"	55	21"
A - largura   B - profundidade			

01 - MH 7560 | 02 - MH 7560 | 03 - MH 7560 | 04 - MH 7599



01

Almofada decorativa 45 x 45 cm com puxado  
Decorative pillow 45 x 45 cm  
Almohada decorativa 45 x 45 cm



02

Almofada decorativa 45 x 45 cm com vivo  
Decorative pillow 45 x 45 cm  
Almohada decorativa 45 x 45 cm



03

Almofada decorativa 45 x 45 cm sem vivo  
Decorative pillow 45 x 45 cm  
Almohada decorativa 45 x 45 cm



04

Almofada decorativa 55 x 55 cm  
Decorative pillow 55 x 55 cm  
Almohada decorativa 55 x 55 cm



01

Almofada decorativa 40 x 40 cm  
Decorative pillow 40 x 40 cm  
Almohada decorativa 40 x 40 cm



02

Almofada decorativa 50 x 50 cm  
Decorative pillow 50 x 50 cm  
Almohada decorativa 50 x 50 cm



03

Almofada decorativa 40 x 40 cm  
Decorative pillow 40 x 40 cm  
Almohada decorativa 40 x 40 cm



04

Almofada decorativa 40 x 40 cm  
Decorative pillow 40 x 40 cm  
Almohada decorativa 40 x 40 cm

01 - MH 7600 | 02 - MH 7601 | 03 - MH 7523 | 04 - MH 7526

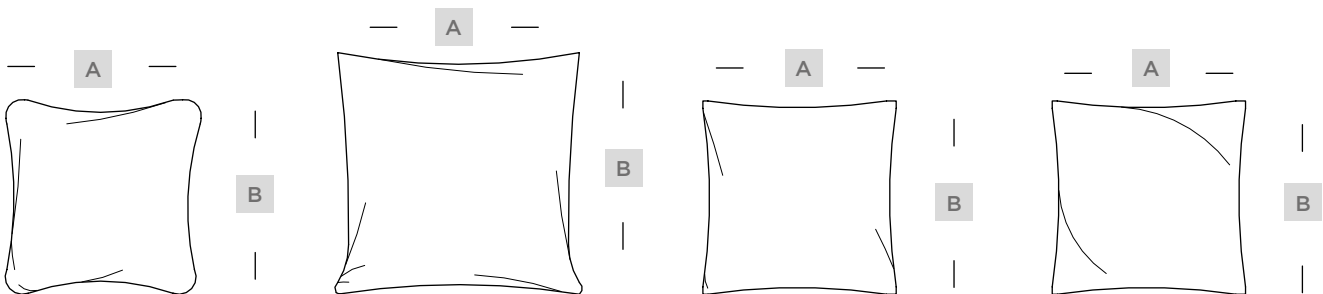

MH 7600			
A		B	
CM	POL.	CM	POL.
40	15"	40	15"
A - largura   B - altura			

MH 7601			
A		B	
CM	POL.	CM	POL.
50	19"	50	19"
A - largura   B - altura			

MH 7523			
A		B	
CM	POL.	CM	POL.
40	15"	40	15"
A - largura   B - altura			

MH 7526			
A		B	
CM	POL.	CM	POL.
40	15"	40	15"
A - largura   B - altura			

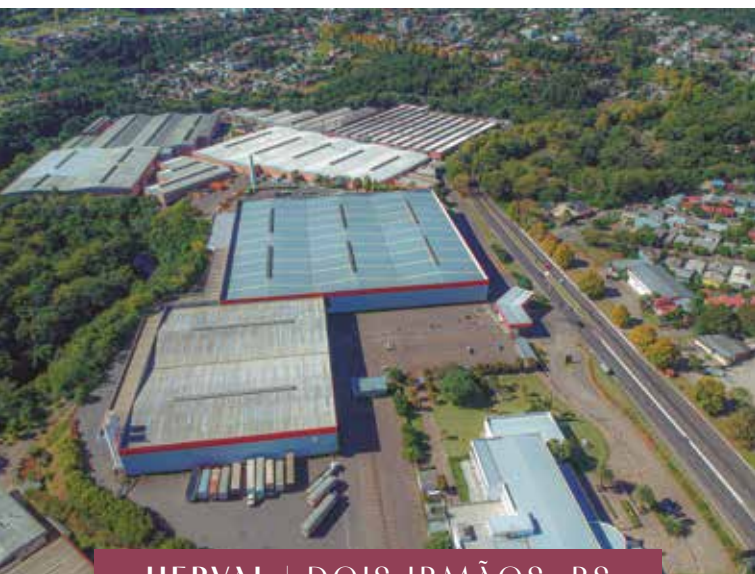

HERVAL | DOIS IRMÃOS, RS

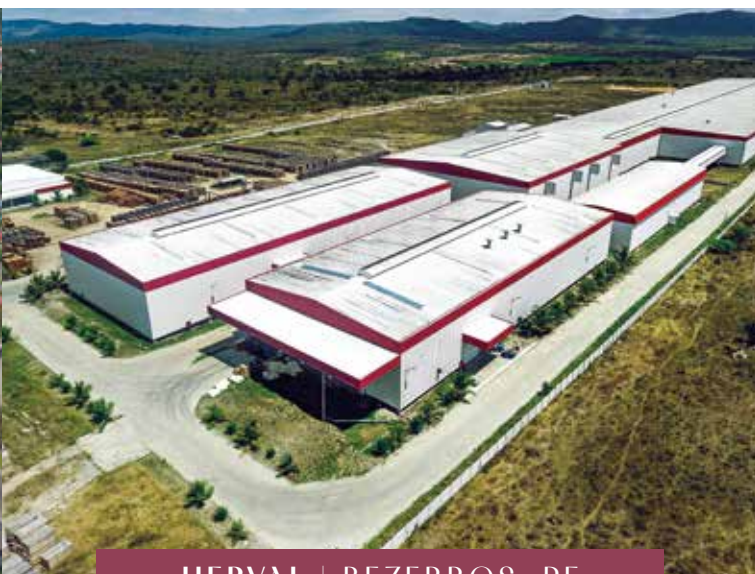

HERVAL | BEZERROS, PE

# GRUPO HERVAL

HERVAL GROUP / GRUPO HERVAL

Em nossos parques fabris, é desenvolvida uma grande variedade de produtos totalmente fabricados pelo Grupo Herval, desde a matéria-prima até a última etapa de cada processo, o que garante a alta qualidade que você conhece. Os estofados Herval são produzidos nos parques fabris de Dois Irmãos - RS e Bezerros - PE, que contam com modernas instalações e tecnologias de última geração.

*At our industrial parks, a wide variety of products developed entirely by the Herval Group are manufactured, from the raw material to the last step of each process, which ensures the high quality you are familiar with. Herval upholstered furniture is produced in the industrial parks of Dois Irmãos - RS and Bezerros - PE, which have modern facilities and use the latest technology.*

*En nuestros parques industriales se desarrollan una amplia variedad de productos desarrollados íntegramente por el Grupo Herval, desde la materia prima hasta la última etapa de cada proceso, lo que garantiza la alta calidad que usted conoce. Los Tapizados Herval se producen en los parques industriales de Dois Irmãos - RS y Bezerros - PE, que cuentan con modernas instalaciones y la última tecnología.*











 [moveisherval.com.br](http://moveisherval.com.br)

  [@hervalmoveisecolchoes](https://www.instagram.com/hervalmoveisecolchoes)